



P R O M O T I O N A L G I F T
C O L L E C T I O N 2 0 2 5



ONLINE CATALOGUE

Explore our detailed table of contents to easily navigate through our comprehensive guide. Find exactly what you're looking for at a glance.

SCAN ME



View this
Catalogue online.

Easy Access

Have it with you all the time, just browse on your computer or mobile phones.

Its Free!

Download it for you and your clients.

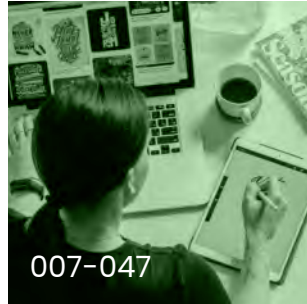

TABLE OF CONTENT

Explore our detailed table of contents to easily navigate through our comprehensive guide. Find exactly what you're looking for at a glance.

006 Technology Gifts

Wireless Chargers, Docking Stations, Headphone & Speakers, Powerbanks, PC and Mobile acc., USB Flash Drives.



102 Promotional Bags

Cotton and Jute Bags, Backpacks, Document Bags, Cooler Bags, Non-woven Bags, Pouches.



153 General Gifts

Keychains, Puzzles, Anti-stress Balls, Card holders, Watches & Clocks, Travel Essentials, Sign Holders, Wearables & more.

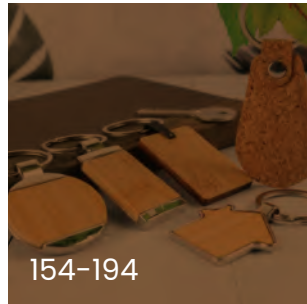

207 ID Solutions

Name Badges and Accessories, Lanyards, Reel Badges, ID Card Holders



248 Promotional Giftsets

Large Selection of Giftsets for your gifting needs.

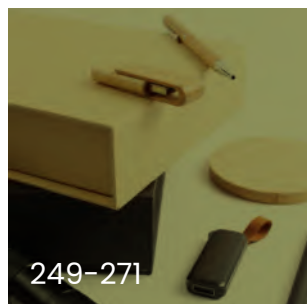

Promotional Stationeries 048

Branded Pens, Plastic & Metal Pens, Eco-friendly Pens, Notebooks, Notepads and Portfolio Folders.

Promotional Drinkwares 125

Promo Bottles, Travel Cups, Ceramic Mugs, Tea coasters Lunchboxes

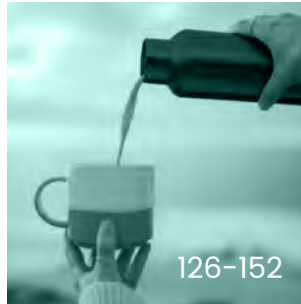

Promotional Pins & Badges 195

Large Selection of Metal Badges, Ready-made Badges, Lapel Pins, and Medals



Awards and Plaques 227

Large Selection of Crystal Awards, 2D & 3D Crystal, Wooden Plaques



Product Packaging 272

Large Selection of Packaging Boxes for your products



BRANDING SERVICES

In order to effectively establish and promote a brand, We are offering a variety of branding options. Choosing the right branding for your product will produce the best visibility on your logo.



360° Rotary UV



UV Printing



DTF Printing



Screen Printing



Digital Printing



Pad Printing



Sublimation



Heat Transfer



Foil Printing



Deboss/Emboss

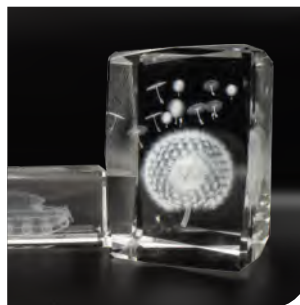

**Crystal 2D/3D
Laser Engraving**



Laser Engraving



Laser Cutting



Laser Markings



Epoxy Doming



**Custom-made
Products**

LOGO INFORMATION

Each Product can be mark with different printing options,
Each printing option have its capabilities and limits
such as; Size, number of used colours, etc.



**Note : All logos that are published in this catalog are only customization sample.
They may slight differ in actual product.**

Ready Stock

Choose from our products & brand it right away!
5000+ different promotional gifts to choose from.
With Large Printing & Production facility, We make sure
we provide you the best branding for your desired gift.

Catalogue Info

Colours of the actual products may slightly differ from
the printed colours shown. Some product sizes have
indicated in cm / mm. Size may vary slightly from those
indicated. We make sure product details are provided,
however due to volume of information some data / info
you need or looking for might have not been included.
**Please request a sample for accurate color, size, design
& information.**

TECHNOLOGY PRODUCTS

Technology gifts have become increasingly popular in today's society, with individuals of all ages and backgrounds seeking the latest gadgets and devices to enhance their daily technology has become an integral part of our lives, permeating every aspect of modern society.



TECHNOLOGY PRODUCTS

Wireless Charging Pads



15W Fast Wireless Charging



WCP-BM6-WHT

Wireless Charger. Made from Bamboo and Recycled ABS Plastic. Compatible with all mobile devices that support Qi wireless charging. Input: 9V / 2.0A. Wireless output: 15W.

100 x 100 x 7 mm

Screen Printing, UV Printing
Laser Engraving



10W Fast Wireless Charging



JU-WCP-BR

Bamboo Wireless Charger. Compatible with all mobile devices that support Qi wireless charging (latest generations of Android and iPhone). Input: 9V / 2A. Wireless output: 10W.

90 x 90 x 9 mm

Screen Printing, UV Printing
Laser Engraving



15W Fast Wireless Charging



JU-WCP-1

Wireless Charger. Compatible with all mobile devices that support Qi wireless charging (latest generations of Android and iPhone). Input: 5V / 1.5A. Wireless output: 15W.

90 x 90 x 8 mm

Screen Printing, UV Printing.



15W Fast Wireless Charging



WCP-L3

Bamboo Wireless Charger Stand with Light-up logo. Compatible with all mobile devices that support Qi wireless charging. Input: DC 5V-1A / 9V-1.1A / 9V-1.7A. Output: 15W (Max)

70 x 115 x 8 mm

Laser Engraving (Light-up)



15W Fast Wireless Charging



Compact & Convenient

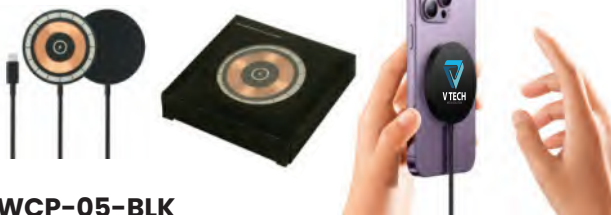

WCP-05-BLK

Round Magnetic Wireless Charger. Designed to provide fast and convenient wireless charging for compatible devices. Input : 5V-2A / 9V-2A / 12V-1.5A. Type-C, 100 cm long cable.

55 x 55 x 5 mm

Screen Printing, Laser Marking
UV DTF Printing,



15W Fast Wireless Charging



WCP-L2

Bamboo Wireless Charger with Light-Up logo. Compatible with all mobile devices that support Qi wireless charging. Input: 5V-1A / 9V-1.1A / 9V-1.7A

90 x 90 x 11 mm

Laser Engraving (Light-up)

- 15W** Fast Wireless Phone Charging
- 2.5W** iWatch Wireless Charging
- 3W** Earbuds Wireless Charging



- Fast Wireless Charging
- Horizontal & Vertical
- Foldable & Portable Size
- Device Intelligent

WCP-L7-BLK

Wireless Charging Station with Light-up logo. Dual-coil design for Phones, watches, and earphones. USB-C Input: 12V/2.5A, 9V/3A, 5V/4A.

- 67 x 18 x 136 mm
- Laser Engraving (Light-up)

- 10W** Fast Wireless Charging



WCP-03

Bamboo Wireless Charger Stand. Compatible with all mobile devices that support Qi wireless charging (latest generations of Android and iPhone). Input: 5V / 2A. Wireless output: 10W.

- 85 x 70 x 135 mm
- Screen Printing, UV DTF Printing
Laser Engraving

Wireless Charging has been around since 1820!

In 1820, using an electric current and a magnetic compass, Danish physicist Hans Christian Oersted originally discovered that electric currents can create a magnetic field. But the history of wireless charging doesn't stop there! A decade later, Michael Faraday, an English scientist, discovered electromagnetic inductive wireless charging!



**A perfect accessory in your Office desk...
Experience the Convenience of a Wireless Charger with Pen Holder Stationery.**

Staying connected and organized is more important than ever. With the rise of remote work and digital communication, having the right tools at your fingertips can make all the difference.



10W Fast Wireless Charging



JU-WDS2-BM

Bamboo Pen holder with Wireless Charger. Simply place your Qi-compatible device on it and let charge. Input: DC9V-2A, Wireless Output: 10W.

160 x 115 x 73 mm

Screen Printing, UV Printing, Laser Engraving



10W Fast Wireless Charging



WDS4

Cork Pen holder with Wireless Charger. Simply place your Qi-compatible device on it and let charge. Input: DC9V-1.5A, Wireless Output: 10W.

152 x 105 x 110 mm

Screen Printing, UV Printing



15W Fast Wireless Charging



WDS6-BLK

Wireless Charger with Pen holder. Made of Bamboo Material and Recycled Plastic with LED light for the Light-Up logo. Ideal for home offices, study spaces, or executive desks.

150 x 80 x 110 mm

Screen Printing, UV Printing
Laser Engraving, UV DTF



15W Fast Wireless Charging



WDS5

Bamboo Wireless Charger with Pen Holders. Simply place your Qi-compatible device on it and let charge. Input : QC18W/9V-2A/PD18W. Output : 5V-1A / 9V-1.1A / 9V-1.7A.

75 x 130 x 130 mm

Laser Engraving, UV DTF
Printing, Screen Printing





15W Fast Wireless Charging



JU-WDS-B

Bamboo Wireless Desk Charging Pad & Organizer. Bamboo material provides a elegant look for this station organizer with built-in wireless charger. Input: 5V-2A, Wireless Output: 15W.

210 x 210 x 18 mm

Laser Engraving
UV DTF Printing

A COMBINATION OF
**Wireless Charger
and Mug Heater**



10W Fast Wireless Charging



WCP-BM7

Bamboo Wireless Charger with Mug Heater. Made of bamboo with a large surface enabling the cup to be heated and the device to be charged simultaneously. Wireless Output: 10W.

183 x 97 x 12 mm

Screen Printing, UV Printing,
Laser Engraving

15W Fast Wireless Charging



WCP-04

Desktop Wireless Charging Stands. Compatible with a wide range of Qi-enabled devices. Crafted with a sleek and modern design. Input: DC 5V, 2A – DC 9V, 2A

90 x 70 x 150 mm UV DTF Printing

15W Fast Wireless Phone Charging

2.5W iWatch Wireless Charging

5W Earbuds Wireless Charging



WCP-08

Foldable Wireless Charger for Mobile, iWatch and Earbuds. Combines convenience and style, featuring a sleek PU leather finish and a foldable design for easy portability.

83 x 80 x 23 mm Screen Printing, UV Printing
UV DTF Printing



- 15W** Fast Wireless Phone Charging
- 2.5W** iWatch Wireless Charging
- 3W** Earbuds Wireless Charging



WDS7

3-in-1 Wireless charging station, magnetic and foldable function. Made from Recycled ABS & Recycled PU. Input: 9V/3A

151 x 125 x 22 mm

Laser Markings, UV DTF Printing



- 15W** Fast Wireless Charging



- ▶ Digital Clock, Alarm Clock, Temperature & Date Display
- ▶ Wireless Charging
- ▶ USB Charging Port



WCP-CLK-01

Wireless Charger with Clock and LED night light. Input: DC 9V - 3A, 12V - 2A | USB Output: 5V - 1A. Charging Efficiency: 73% and Charging distance: ≤ 3-6 mm.

168 x 118 x 111 mm

UV DTF Printing





15W Fast Wireless Charging



Touch Dimming function



USB-C Input: PD/QC12V-3A, 9V-3A
USB-C Output: 5V-2A (MAX)
USB-A Output: 5V-2A (MAX)



Plain Black option



Cork option



Adjustable Lamp light & position

Clock & alarm functions

Desktop station & charging ports



WCP-CLK-03

Desk Lamp with Wireless Charger, Clock and Pen Holder. Perfect for home offices, corporate settings, or as a thoughtful gift, it's the ultimate blend of practicality and modernity.

130 x 155 x 445 mm



Screen Printing, UV Printing
 UV DTF Printing

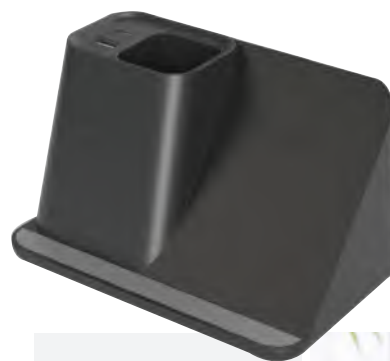

Anti-Slip Silicone Pad

WDS3-BK

Multifunctional Desktop Pen Holder with Wireless Charging. USB A & USB C charging ports, Input : DC 5V / 2 A, USB A & USB C Output : 5V-2A (max). Wireless output : 5W.

156 x 98.5 x 95 mm



Laser Engraving (Light-up)

Speakers & Headphones

When it comes to enjoying music, podcasts, or watching movies, having the right speakers and headphones can make all the difference in your audio experience. With so many options available in the market, it can be overwhelming to choose the best ones for your needs.



Bluetooth®

15W Fast Wireless Charging

SPK-L6
Wireless Charger Bluetooth Light-up Logo Speaker.
Input : 5V/3A - 9V/3A. Speaker output: 3W, Battery: 1200mAh.
Working time: 3-4 hours.

102 x 102 x 200 mm Laser Engraving (Light-up) UV DTF Printing



A COMBINATION OF
Wireless Charger and Speaker



15W Fast Wireless Charging



SPK-WC4-BLK

Multi-function Wireless Charger Bluetooth Speaker with Digital Clock, Black ABS material with LED light up logo. Loudspeaker Output: 3W, Wireless Output: 15W.

97 x 122 x 91 mm Laser Engraving (Light-up)



MS-05

Bluetooth Speaker with Wireless Charging. Light up logo. Mobile holder with wireless function. Frequency Response: 100Hz-20KHz. Loudspeaker Output: 3W, Wireless Output: 5W.

112 x 83 x 76 mm Laser Engraving (Light-up)



MS-06

Mini Cube Bluetooth Speaker. Light up logo bluetooth speaker. Small & Portable design. Frequency Response: 100Hz - 20KHz. Loudspeaker Output: 3W.

41 x 41 x 46 mm Laser Engraving (Light-up)



ECO Music Bluetooth®



SPK-BM4-WHT

Bluetooth Speaker. Made from Bamboo and Recycled Plastic. Speaker output : 5W, Input port : AUX, Lithium-polymer battery : 1200mAh, Playtime : (75% volume) 6 hours.

75 x 75 x 88 mm

Screen Printing, UV Printing
UV DTF

ECO Fast Wireless Charging Bluetooth®

10W Fast Wireless Charging



MS-10

Night Light Wireless Speaker, Charger & Lamp. Compatible with Qi-Standards mobile devices. Nightlamp has 3 level of Brightness. Touchbuttons, Portable and Simple to use.

110 x 92 x 137 mm

Screen Printing, UV Printing
Laser Engraving, UV DTF



SPK-005-BLK

Bluetooth Fabric Speaker. ABS material speaker with strap. Has a memory card slot and FM radio function. Long lasting battery life and compatible with most mobile phones.

115 x 35 x 75 mm

UV Printing, Laser Engraving

ECO   Bluetooth®



MS-08

5.0 Bluetooth speaker with bamboo topside design & black rubberized base. Multicolor LED light on the middle. 300 Mah Lithium-ion battery. SD card port & micro-usb charging port.

 60 x 60 x 50 mm  Screen Printing, UV Printing Laser Engraving

ECO    Bluetooth®



 Interchangeable LED light into 4 different colors.



MS-09

Lamp Bamboo 5.0 Bluetooth Speaker. Wireless Speaker made from natural bamboo. Has an integrated mood light that can light up in multicolor. Playing time: 2-3 hrs. Capacity : 350mAh.

 60 x 105 mm  Laser Engraving, UV DTF

ECO    Bluetooth®

15W Fast Wireless Charging



MS-11

5.1 Bluetooth Bamboo Speaker with Wireless Charger. Top area has a 15W wireless charging function. 400mAh Battery. Charging time : 2 hours. Playing time : 3 hours.

 62 x 64 mm  Screen Printing, UV Printing Laser Engraving.



TECHNOLOGY PRODUCTS

Limestone Cement & Bamboo

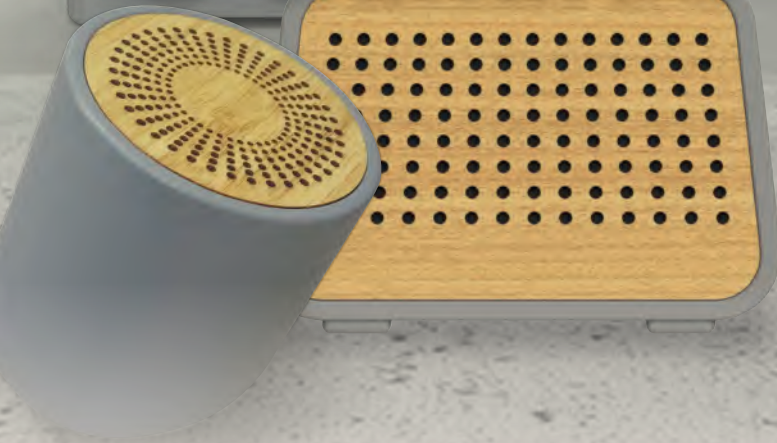

ECO Bluetooth®



MS-CW1

Wireless Charger Speaker, Li-ion polymer battery: 600mAh, Distance: 10 meters, Loudspeaker output: 5W, Frequency: 200Hz -18kHz, Signal to Noise: >90dB. Input: DV 5V-2A.

107 x 75 x 64 mm



Screen Printing, UV Printing
Laser Engraving.

ECO Bluetooth®



MS-CW2

Wireless Charger Speaker, Li-ion polymer battery: 600mAh, Distance: 10 meters, Loudspeaker output: 5W, Frequency : 100Hz - 15kHz, Signal to Noise: >85dB. Input : DV 5V-2A

23 x 86.5 x 57 mm



Screen Printing, UV Printing
Laser Engraving.

ECO Bluetooth®



MS-C3

Bluetooth Speaker, Li-ion polymer battery: 500mAh, Distance: 10 meters, Signal-To-Noise: >80d. Loudspeaker output: 5W, Frequency : 100Hz -15kHz. Input : DV 5V-2A.

71 x 73 mm



Screen Printing, UV Printing
Laser Engraving.



WIRED



EAR-01

Earphone presented on a white & grey plastic protective case, White earphone with a 3mm earphone jack. Cable length : 105 cm.

 68 x 45 x 22 mm

 Screen Printing, UV Printing.

     Bluetooth®



EAR-04

Bluetooth earphones in bamboo case. Incredible Sound Quality, Comfortable Fit & Wide compatibility. Bluetooth Distance : 10m, Stereo Sound, Input : 5V, 0.3A

 47 x 75 x 30 mm

 Screen Printing, UV Printing
Laser Engraving

WIRELESS





Bluetooth®



EAR-B5-WHT

Bluetooth headphone with touch of bamboo. Portable and adjustable. Radio, microphone and micro SD slot functions. Output : 10mW, Input: 3.7V, Frequency : 2.402 - 2.480Ghz

170 x 185 mm



Screen Printing, UV Printing
Laser Engraving



Bluetooth®



EAR-03

Bluetooth headphones. ABS. Cushioned structure, bluetooth transmission and TF card reader. Functions include modes, volume control, play / pause button. 3.5mm headphone slot.

160 x 180 x 80 mm



Screen Printing, UV Printing
Digital Printing with Epoxy,
Laser Markings

TECHNOLOGY PRODUCTS

Promotional Powerbanks

In today's digital age, staying connected has become more critical than ever. Having a reserved battery charge is must.



15W Fast Wireless Charging



Battery capacity
10,000 mAh

WPB-B10K

10,000 mAh Bamboo Wireless Powerbank with transparent design. Type-C Input : 5V/2A, USB Output : 5V/4.5A, 9V/2A, 12V/1.5A. Type-C output: 20W

 100 x 70 x 23 mm

 Screen Printing, UV Printing
Laser Engraving.



Did you Know?

Fastest way to charge and save energy on your power bank.

Some smart phones automatically update the latest software, which consumes more battery power, if you want to save energy from a powerbank then put your phone on flight mode that will disable your network, and which enables to charge much faster.



15W Fast Wireless Charging



Battery capacity
8,000 mAh



JU-WPB-B8000

8,000 mAh Bamboo Wireless Powerbank. Powerful, sustainable and ecologically responsible wireless charging. 2 Input (micro & type C): DC 5V/2A, 2 USB Output : DC 5V/2A.

145 x 68 x 16 mm



Screen Printing, UV Printing, Laser Engraving



5W Wireless Charging



Battery capacity
8,000 mAh



WPB-CO-8K

8,000 mAh Cork and Wheat Straw Wireless ECO Friendly Powerbank, Lithium Polymer Battery. Input (micro & type C): DC 5V/2A. 2 USB Output : DC 5V/2.1A, Wireless Output : 5W.

135 x 71 x 16 mm



Screen Printing, UV Printing



1 SLOT USB PORT



Battery capacity
5,000 mAh



PB-5K-BM

Bamboo Portable Powerbank. The ideal gift or handout item for business events. Input and Output (type C): DC 5V/2A, USB Output: DC 5V/2A.

65 x 15 x 100 mm



Screen Printing, UV Printing Laser Engraving, UV DTF



- 15W** Fast Wireless Phone Charging
- 2.5W** iWatch Wireless Charging
- 3W** Earbuds Wireless Charging



Battery capacity
10,000 mAh



WPB-S10K

10,000 mAh magnetic wireless powerbank with iWatch charger.
 USB-C Input : 5V/3A, 9V/2A
 Built-in USB-C Input: 5V/3A, 9V/2A, 12V/1.5A
 Built-in USB-C Output: 5V/3A, 9V/2.22A, 12V/1.67A
 USB-A Output : 5V/3A, 9V/2A, 12V/1.5A
 USB-A & Built-in USB-C cable output : 5V/3A

146.5 x 70.5 x 18 mm UV Printing



Fast Charging Powerbank with Built-in Cables



WHT



BLK

Type-C Line Output :
 4.5V/5A, 5V/3A, 9V/2A, 12V/1.5A
Type-C Input :
 5V/3A, 9V/2A, 12V/1.5A
Micro Input :
 5V/2A, 9V/2A, 12V/1.5A
Type-C Output :
 5V/3A, 9V/2A, 12V/1.5A
USB Output :
 4.5V/5A, 5V/3A, 9V/2A, 12V/1.5A

Battery capacity
10,000 mAh

PB-10K

10,000 mAh Powerbank with LED screen and built-in cables. provides a blend of convenience, efficiency, and versatility, making it a valuable accessory for modern life.

69 x 18 x 144 mm Screen Printing, UV Printing
UV DTF Printing



DORNIEL
DESIGNS



15W Fast Wireless Charging



Battery capacity
10,000 mAh



WPB-L10K
10,000 mAh Light-Up Logo Wireless Powerbank with linen design. Type-C Input : 5V/2.5A, Type-C Output : 5V/2A, USB Output 1 & 2 : 5V/2A. Wireless Charging Output : 15W.

 146.5 x 70.5 x 18 mm  Laser Engraving (Light up)



DORNIEL
DESIGNS



15W Fast Wireless Charging



Battery capacity
10,000 mAh



WPB-L10K-SADU
10,000 mAh Light-Up Logo Wireless Powerbank with sadu design. Type-C Input : 5V/2.5A, Type-C Output : 5V/2A, USB Output 1 & 2 : 5V/2A. Wireless Charging Output : 15W.

 146.5 x 70.5 x 18 mm  Laser Engraving (Light up)



W



BK



20W Lightning Cable
22.5W Type-C Cable
22.5W USB Port
 LED Flash Light Function
 Digital Screen Display



Battery capacity
30,000 mAh



PB-30K-WHT

30,000 mAh Powerbank with Built-in cables, Digital Screen & leather strap. Semi matte finish. Lithium Polymer Battery.

70 x 44 x 153 mm

Screen Printing, UV Printing



2 SLOT
 USB PORT



Battery capacity
5,000 mAh



JU-PB-5000

5,000 mAh Mini Size Powerbank. Slim & Portable Design. 4 dot light battery indicator. Lithium Polymer Battery. Input : DC 5V/2.1A, Output : DC 5V/2.1A.

63 x 13 x 90 mm

Screen Printing, UV Printing

TECHNOLOGY PRODUCTS

PC & Mobile Accessories

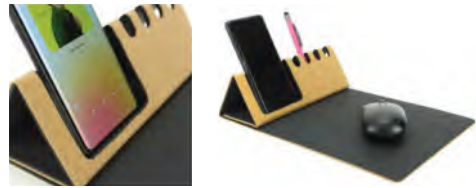

MPD-260-CO

Foldable Cork+PU Mousepad with Mobile and Pen Holder. Provides a range of functionalities that enhance its utility as a valuable addition to the contemporary work environment.

215 x 10 x 315 mm



Screen Printing, UV Printing
Debossing



10W Fast Wireless Charging



WCM3-BLK

Mousepad with Wireless Charger and desk organizer. Made from PU and Bamboo material. Compatible with Qi-enabled gadgets.

255 x 255 x 15 mm



Heat Transfer, Screen Printing
UV DTF, Deboss & Emboss



15W Fast Wireless Charging



WCM4-BLK

RPET Wireless Charging Mousepad with handrest for support. The wireless charging pad exhibits compatibility with a diverse array of Qi-enabled gadgets.

350 x 235 x 15 mm



Screen Printing, UV DTF



10W

Fast Wireless Charging



JU-WCM1-CO

Cork Foldable Mousepad with Wireless Charging.
Foldable Design: Mousepad Mode / Compact Mode/ Dock Mode.

263 x 203 mm

Screen Printing, UV Printing.



10W

Fast Wireless Charging



JU-WCM1-GY

Fabric Foldable Mousepad with Wireless Charging.
Foldable Design: Mousepad Mode / Compact Mode/ Dock Mode.

263 x 203 mm

Screen Printing



261

Round Mousepad. Made from Cork material. 3mm thickness.

230 mm (dia)

Screen Printing



262

Non-slip White Fabric Mousepad.

197 x 180 mm

Sublimation



266-A

Rectangular Mousepad. For full color edge-to-edge printing. Made of rubber and fabric.

 230 x 200 mm

 Sublimation



WM3-BLK

Wireless Mouse with LED. Matte textured body. Bluetooth with USB 2.4GHz & Type-c Receiver. 3 Adjustable DPI Sensitivity.

 57 x 113 x 20 mm

 UV Printing, UV DTF



WM4

Wireless mouse with Bamboo & Recycled Plastic. Designed for versatility, offers Bluetooth 5.0 and a 2.4GHz USB receiver, ensuring compatibility with a wide range of devices.

 105 x 60 x 30 mm

 UV DTF Printing, UV Printing, Laser Engraving,



MPS-08

Foldable Phone Stand with touch of bamboo. Non-slip base. Adjustable height up to 160mm.

65 x 125 x 110 mm,

Screen Printing, UV Printing, Laser Engraving.

LARGE SELECTION OF

Mobile Phone Holders

A ubiquitous accessory in today's world as mobile phones have become an essential part of daily life.



MPS-07-BM

Eco-friendly Phone holder stand made from Bamboo. It has a hole slot design for the charging cable and has detachable feature for easy storage.

80 x 130 x 85 mm

Screen Printing, UV Printing, Laser Engraving.



MPS-10

Bamboo Easel Phone Holder. Sleek, eco-friendly accessory designed to keep your phone propped up at an optimal viewing angle.

110 x 150 x 30 mm

Screen Printing, UV DTF Printing, Laser Engraving

Foldable design
for easy storage

Suitable for
Most Mobile Phones
& even Tablets.



MPS-05

Mobile Phone Stand. Small & Portable Design, A foldable mobile holder for mobile device and with PVC non-slip stops.

 90 x 30 x 10 mm

 Screen Printing, UV Printing.



KH-14-BM

Bamboo Phone holder stand with Keyring. Made from real bamboo material. Slim and portable design.

 25 x 60 x 15 mm

 Screen Printing, UV Printing,
Laser Engraving



MPS-09-BM

Bamboo Phone holder stand. Simple and durable. Dual holder with two different slot thicknesses to fit various phone models.

 60 x 80 x 20 mm

 Screen Printing, UV Printing,
Laser Engraving

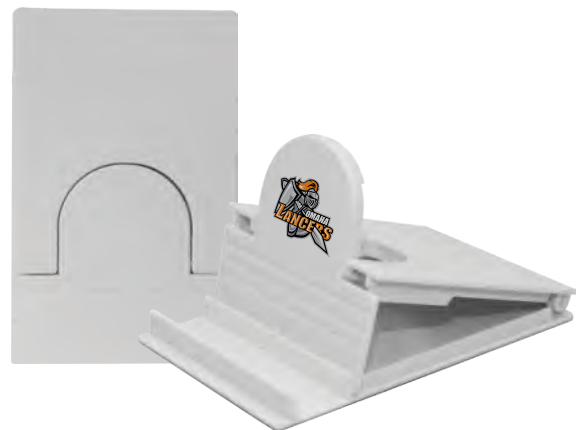

MPS-06

Promotional Mobile Phone Stand. White plastic mobile stand in a foldable design. Great holder for your full color printing.

 60 x 98 x 8 mm

 Screen Printing, UV Printing



W

BK



MPP-01

Silicone Card holder sticks to the back of phones and phone cases providing a pocket for plastic cards. Supplied with a microfibre sticky screen cleaner.

60 x 89 mm

Sublimation



SL

BK



PR

Metal Phone ring. Practical in nature and simple, this mobile phone holder enhances your grip on your smart device as you use it.

33 x 33 mm

Laser Markings



W

BK



PR-02

Round Mobile Grip and Stand. Pop-up function for a grip & stand for your mobile devices. Slim and Portable design.

40 mm (dia.)

Screen Printing, UV Printing.



PR-03

Phone ring with car air vent holder. Use as a mobile phone ring and also as a mobile holder on your car's air vent.

30 x 30 mm

Laser Markings



20W USB + Type C Output



TA-005

Fast Charging Universal Travel Adaptors 20W with Bamboo. 4 types of Plug (UK, AUS, USA, EURO), Input : 100-240VAC - 50-60Hz. USB+Type C Output : QC18W + PD20W.

50 x 40 x 75 mm



Screen Printing, UV Printing
Laser Engraving, UV DTF



JU-TA-004

Promotional Travel Adaptor. High Quality & Portable. 4 types of Plug (UK, AUS, USA, EURO), AC Voltage: 100-240V. Dual USB Output: 5V 2.4A. With dual 8A fuses inside.

60 x 50 x 45 mm



Screen Printing, UV Printing



JU-TA-001-W

Promotional Travel Adaptor. High Quality & Portable. 4 types of Plug (UK, AUS, USA, EURO), input : AC 6A Max. 100-240 Vac 50/60Hz. Output : USB 1A Max. 5V DC.

62 x 55 x 46 mm



Screen Printing, UV Printing



15W Fast Wireless Charging



WCC-BM3-WHT

Bamboo Car Phone Holder with Wireless Charger. Car air vent mount and adjustable clamp. Compatible with any Qi-standard enabled smartphone. Input : Type C 9V/2A.

75 x 110 x 60 mm

Laser Engraving, UV DTF



CARC-S2

Swivel USB Car Charger. Small & Portable design, with Key Ring attachment. Input : 12V - Output : 5V < 2.100mA (via USB).

64 x 24 mm

Screen Printing, UV Printing, Digital Printing with Epoxy



CARC

USB Car Charger. Ultra Lightweight & Portable design, LED corner light Full color printed with epoxy on center. Input : 12V - Output : 5V < 2100mA (via USB).

30 x 25 x 70 mm

Screen Printing, UV Printing, Digital Printing with Epoxy

TECHNOLOGY PRODUCTS

Charging Cables



OC-BL4

Light-Up Logo Bamboo Multi-charging - Long Cable (Nylon braided). 3 in 1 charging USB cable featuring the TypeC, Lightning & micro USB connectors. Input : USB 5V - Max to 2.1 A.

35 mm (bamboo) Laser Engraving (Light-up)
Cable : 100 cm



OC-L7

Light-Up Logo Multi-charging - Long Cable. 5 in 1 charging USB cable featuring the TypeC, Lightning & micro USB connectors. Input : USB 5V - Max to 2.1 A.

Cable : 120 cm Laser Engraving (Light-up)



OC-BL3

Light-Up Logo Bamboo Multi-charging Cable (Nylon braided). 3 in 1 charging USB cable featuring the TypeC, Lightning & micro USB connectors. Input : USB 5V - Max to 2.1 A.

28 x 10 x 170 mm Laser Engraving (Light-up)



JU-OC-L2

Light Up Logo Multi-charging Cable (Nylon braided). 3 in 1 charging USB cable featuring the Type C, Lightning & micro USB connectors. Input : USB (5V - Max to 2.1 A).

25 x 155 x 10 mm Laser Engraving (Light-up)



OC-BS6

Multi-Charging Cable Set in Square Bamboo Case. Ports: Type A, Type C, Micro USB, and lightning port. Versatile set designed to keep all your devices powered up with ease.

78 x 78 x 16 mm Screen Printing, UV Printing, Laser Engraving



OC-BR5

Multi-Charging Cable Set in Round Bamboo Case. Ports: Type A, Type C, Micro USB, and lightning port. Versatile set designed to keep all your devices powered up with ease.

80 x 80 x 16 mm Screen Printing, UV Printing, Laser Engraving

Promotional USB Flash Drives

We specialize in importing quality USB Flash Drives for promotional purposes. Our USB Flash Drives are sourced from reputable factories using quality components. We pride ourselves on high standard levels and after sales services.

Benefits of Using USB Flash Drives

- **Portability:** USB flash drives are small and lightweight, making them easy to carry around wherever you go.
- **Compatibility:** USB flash drives are compatible with a wide range of devices, including computers, laptops, and smartphones.
- **Ease of Use:** Transferring files to and from a USB flash drive is quick and simple, even for beginners.
- **Security:** USB flash drives can be encrypted to protect sensitive data from unauthorized access.

Reasons why you choose us as your USB Flash Drive source.

- We import original chips separately and after testing & quality checking, We fix them in USB shells.
- We never import duplicate or upgrade chips and we offer warranty against defect.
- Fast delivery from ready stock.
- Big variety and range of products to select.
- Competitive prices with higher quality.
- Mock Ups and E-Samples

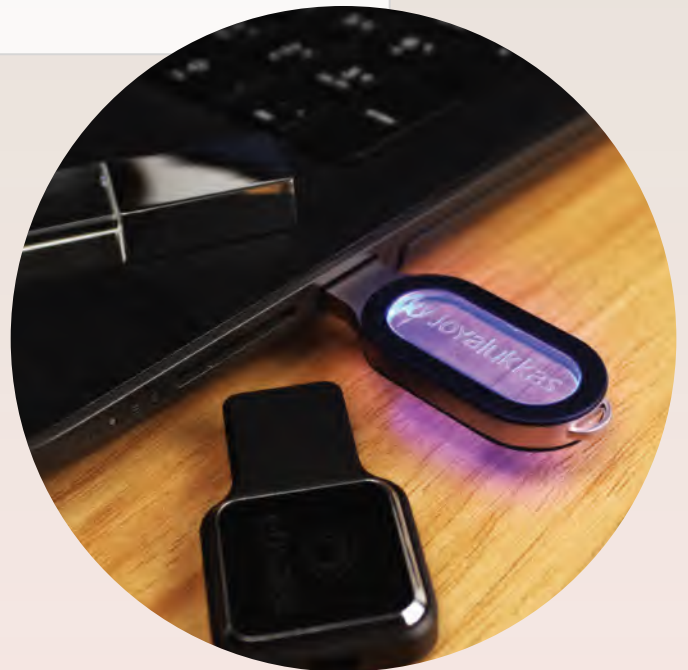

**We never use upgrade chips
We use only original chips!**

LOGO

Ready Stock : USB v3.0

64GB



USB-78-BLK

Black Light-Up USB Flash Drive.

60 x 21 x 13 mm

Laser Engraving (Light-up)

LOGO

Ready Stock : USB v2.0
Pre-Order : USB v3.0

32GB



USB-76-BK

Black Leather Flash Drive with Magnetic Closure and It has an LED light Feature for the Light-Up Logo.

75 x 25 x 8.5 mm

Laser Engraving (Light-up)

16GB

Ready Stock : USB v2.0
Pre-Order : USB v3.0



USB-73

Grey & Black Slide USB Flash Drive

57 x 20 x 10 mm

Screen Printing, UV Printing.

LOGO

Ready Stock : USB v2.0
Pre-Order : USB v3.0

16GB



USB-72

Silver Metal Light-Up USB Flash Drive with Strap.

52 x 20 x 8 mm

Laser Engraving (Light-up)

LOGO

Ready Stock : USB v2.0
Pre-Order : USB v3.0

16GB



USB-71

Silver Metal Light-Up USB Flash Drive.

60 x 18 x 5 mm

Laser Engraving (Light-up)

LOGO

Ready Stock : USB v2.0
Pre-Order : USB v3.0

16GB



USB-70

Silver Metal Light-Up USB Flash Drive with Hook.

70 x 12 x 5 mm

Laser Engraving (Light-up)

LOGO

Ready Stock : USB v2.0
Pre-Order : USB v3.0

16GB



USB-69

Silver Metal Light-Up USB Flash Drive.

65 x 12 x 5 mm

Laser Engraving (Light-up)

32GB

16GB

8GB

4GB

Ready Stock : USB v2.0
Pre-Order : USB v3.0



USB-68

Black Metal USB Flash Drive with Ring

45 x 12 x 5 mm

Screen Printing
Laser Markings

LOGO

Ready Stock : USB v2.0
Pre-Order : USB v3.0

16GB



USB-67

Square Light Up USB Flash Drive. Square logo area with LED light for engraving.

52 x 30 mm

Laser Engraving (Light-up)

LOGO

Ready Stock : USB v2.0
Pre-Order : USB v3.0

16GB



USB-66

Metal with Crystal USB Flash Drive. Oval crystal area for your logo with LED light.

68 x 23 mm

Laser Engraving

64GB

32GB

16GB

8GB

4GB

Ready Stock : USB v2.0
Pre-Order : USB v3.0



USB-65

Metal Hook USB Flash Drive. Slim and Portable design

48 x 15 x 4 mm

Laser Markings

64GB

32GB

16GB

8GB

4GB

Ready Stock : USB v2.0
Pre-Order : USB v3.0



USB-64

Element Metal USB Flash Drive. Slim and Portable design. Available in Black or Gun metal color

BK - 43 x 12 x 5 mm
GM - 35 x 12 x 5 mm

Laser Markings

64GB

32GB

16GB

8GB

4GB

Ready Stock : USB v2.0
Pre-Order : USB v3.0



USB-62

Metal USB Flash Drive with keyring. Available in Black or Gun metal color.

 45 x 12 x 10 mm

 Laser Markings

64GB

32GB

16GB

8GB

4GB

Ready Stock : USB v2.0
Pre-Order : USB v3.0



USB-54

Metal Clip USB Flash Drive. The structure is portable and practical.

 55 x 12

 Screen Printing, UV Printing
Laser Markings

64GB

16GB

8GB

Ready Stock : USB v2.0
Pre-Order : USB v3.0



USB-58

Crystal Keychain USB Flash Drive. A distinctive appearance thanks to their premium rectangular crystal glass.

 59.5 x 18 x 10 mm

 Laser Engraving,
Screen Printing

SL BL R

16GB

8GB

Ready Stock : USB v2.0
Pre-Order : USB v3.0



USB-59

Round Crystal USB Flash Drive. Make a wonderful gifts to present to devoted customers or important ones.

 58 x 30 x 12 mm

 Laser Engraving,
Screen Printing



- 64GB
- 32GB
- 16GB
- 8GB
- 4GB

Ready Stock : USB v2.0
Pre-Order : USB v3.0



USB-18

Leather with Chrome Finish USB Flash Drive. Available in Black or White leather.

67 x 23 x 10 mm Screen Printing, UV Printing

- 64GB
- 32GB
- 16GB
- 8GB
- 4GB

Ready Stock : USB v2.0
Pre-Order : USB v3.0



USB-23

Thin White USB Flash Drive with Chrome Base. Slide to open the USB part.

57 x 20 x 10 mm Screen Printing, UV Printing

- 64GB
- 32GB
- 16GB
- 8GB
- 4GB

Ready Stock : USB v2.0
Pre-Order : USB v3.0



USB-20

Plastic Slide USB Flash Drive with Leather Strap. Available in 6 different colors.

67 x 23 x 10 mm Screen Printing, UV Printing

- W
- BK
- GR
- BL
- R
- Y

- 64GB
- 32GB
- 16GB
- 8GB
- 4GB

Ready Stock : USB v2.0
Pre-Order : USB v3.0



USB-7

Key shaped Metal USB Flash Drive. Available in 5 different colors.

57 x 25 mm Laser Markings
UV Printing

- W
- SL
- BK
- BL
- R

- 64GB
- 32GB
- 16GB
- 8GB
- 4GB

Ready Stock : USB v2.0
Pre-Order : USB v3.0



USB-28

Mini Swivel USB Flash Drives. Metallic body, keyring and handy size, make it easier to carry. Available in 3 different colors.

35 x 14 mm Screen Printing, UV Printing
Laser Markings

- W
- BK
- R

- 64GB
- 32GB
- 16GB
- 8GB
- 4GB

Ready Stock : USB v2.0
Pre-Order : USB v3.0



USB-09

Metal USB Flash Drives. Available in 6 different colors.

75 x 25 x 8.5 mm Screen Printing, UV Printing
Laser Markings

- W
- SL
- BK
- BL
- R
- G

1060

Ready Stock : USB v3.0

64GB



USB-78-BM

Bamboo Round Light-up USB Flash Drive with Leather Strap.



62 x 38 x 10 mm



Laser Engraving (Light-up)

1060

Ready Stock : USB v3.0

64GB



USB-77-BM

Bamboo Rectangular Light-up USB Flash Drive with Leather Strap.



70.5 x 18 x 10 mm



Laser Engraving (Light-up)

64GB

32GB

16GB

8GB

4GB

Ready Stock : USB v2.0
Pre-Order : USB v3.0



USB-25

Leather Keychain USB Flash Drive. A chilly brown-colored leather. Easy and portable.



80 x 20 mm



Laser Markings
Screen Printing

Eco

1060

Ready Stock : USB v2.0
Pre-Order : USB v3.0

64GB

32GB

16GB

8GB

4GB



USB-13

Wooden USB Flash Drive. Elegant and portable design. Sustainable wooden casing.



60 x 30 mm



Laser Engraving
Screen Printing

Eco

1060

Ready Stock : USB v2.0
Pre-Order : USB v3.0

64GB

32GB

16GB

8GB

4GB



USB-38

Bamboo USB Flash Drive. Laser engraving for organic branding. Sustainable bamboo casing.



65 x 18 mm



Screen Printing, UV Printing
Laser Engraving

1060

Ready Stock : USB v2.0
Pre-Order : USB v3.0

32GB



USB-75

Light-up Logo Metal with Bamboo USB Flash Drive



65 x 15 x 4.5 mm



Laser Engraving (Light-up)

LARGE SELECTION OF

Swivel Flash Drives

The need for portable storage solutions has never been greater. Whether you're a student, professional, or tech enthusiast, having quick and easy access to your files on the go is essential.

One popular option that has stood the test of time is the **Swivel USB flash drive**. These compact and versatile devices offer a convenient way to store, transfer, and access your data wherever you are.

Ready Stock : USB v2.0
Pre-Order : USB v3.0



USB-35-BK-M 4GB 8GB 16GB 32GB 64GB

Matte Black Swivel USB Flash Drive. **Product Size** : 58 x 20 x 11 mm.
Printing Options : UV Printing, Screen Printing.



USB-35-BL-M 4GB 8GB 16GB 32GB 64GB

Blue Swivel USB Flash Drive. **Product Size** : 58 x 20 x 11 mm.
Printing Options : UV Printing, Screen Printing.



USB-35-W 4GB 8GB 16GB 32GB 64GB

White Glossy Swivel USB Flash Drive. **Product Size** : 58 x 20 x 11 mm.
Printing Options : UV Printing, Screen Printing.



USB-35-S 4GB 8GB 16GB 32GB 64GB

Silver Swivel USB Flash Drive. **Product Size** : 58 x 20 x 11 mm.
Printing Options : Laser Markings, Screen Printing.



USB-35-SS 4GB 8GB 16GB 32GB 64GB

Shiny Silver Swivel USB Flash Drive. **Product Size** : 58 x 20 x 11 mm.
Printing Options : UV Printing, Screen Printing.



USB-35-SG 4GB 8GB 16GB 32GB 64GB

Shiny Gold Swivel USB Flash Drive. **Product Size** : 58 x 20 x 11 mm.
Printing Options : UV Printing, Screen Printing.



USB-35-S-1L 4GB 8GB 16GB 32GB 64GB

Silver Swivel USB Flash Drive with Debossed area for branding.
Product Size : 58 x 20 x 11 mm. **Printing Options** : Digital Printing with Epoxy. - **1 Sided Printing**



USB-35-S-2L 4GB 8GB 16GB 32GB 64GB

Silver Swivel USB Flash Drive with Debossed area for branding.
Product Size : 58 x 20 x 11 mm. **Printing Options** : Digital Printing with Epoxy. - **2 Sided Printing**



64GB

32GB

16GB

8GB

4GB

Ready Stock : USB v2.0
Pre-Order : USB v3.0

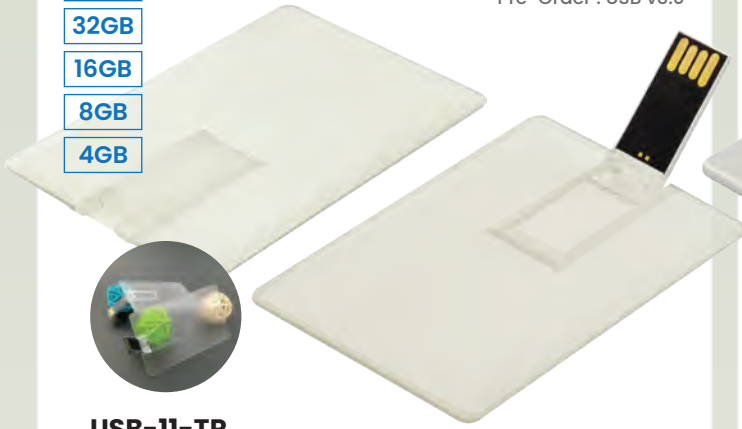

USB-11-TR

Transparent PVC USB Flash Card. Portable and slim configuration.

84 x 54 mm

Screen Printing, UV Printing

64GB

32GB

16GB

8GB

4GB

Ready Stock : USB v2.0
Pre-Order : USB v3.0



USB-11-M

Aluminum USB Flash Card. Portable and slim configuration.

84 x 54 mm

Screen Printing, UV Printing

64GB

32GB

16GB

8GB

4GB

Ready Stock : USB v2.0
Pre-Order : USB v3.0



USB-36

PVC Rectangular Shaped Mini USB Flash Card. Slim and Portable design.

60 x 30 mm

Screen Printing, UV Printing

64GB

32GB

16GB

8GB

4GB



USB-11

PVC USB Flash Card. Easily transportable and slim design. Available in 2 solid colors

84 x 54 mm

Screen Printing, UV Printing

64GB

32GB

16GB

8GB

4GB

Ready Stock : USB v2.0
Pre-Order : USB v3.0



USB-56

PVC Round Shaped Mini USB Flash Card. Slim and Portable design.

40 x 40 mm

Screen Printing, UV Printing

LARGE SELECTION OF

Promotional OTG Flash Drives



Photo



Music



Videos



Documents

Data transfer between platforms without the use of data cables.

This Flash drives are a type of USB flash drive that can be directly connected to a smartphone or tablet, without the need for a computer as an intermediary.

One of the most significant developments in the field of data storage and transfer has been the emergence of OTG (On-The-Go) flash drives.

32GB



USB-74-BM

Bamboo Swivel Flash Drive. OTG Combo. USB & Type C port.

75x 20 x 11 mm



Screen Printing, UV Printing
Laser Markings

32GB

Ready Stock : USB v3.0



USB-79-GM

Phone USB - OTG Combo. USB & Type C port.

68 x 22.5 x 8.5 mm



Laser Markings

64GB

Ready Stock : USB v3.0



USB-82-GM

Swivel Phone USB - OTG Combo. USB & Type C port.

62 x 19 x 9 mm



Laser Markings

16GB



USB-15

Swivel Phone USB - OTG Combo. USB & Type C port.

60 x 16.5 x 9.5 mm



Screen Printing,
Laser Markings

64GB

Ready Stock : USB v3.0



USB-80-W

White Swivel Phone USB - OTG Combo. USB & Type C port.

69 x 19.5 x 10 mm

Screen Printing, UV Printing

1060

32GB

Ready Stock : USB v3.0



USB-81-BK

Black Phone USB - OTG Combo. USB & Type C port.

61 x 20 x 8 mm

Laser Engraving (Light-up)

In today's fast-paced digital world, having a reliable way to transfer and store data is essential for both personal and professional use. One technology that has gained popularity in recent years is the OTG flash drive. But what exactly is an OTG flash drive, and how can it benefit you?

How to Use an OTG Flash Drive

Connect the OTG Flash Drive to your mobile device: Insert the USB connector of the OTG flash drive into your device's USB port. The device should automatically detect the flash drive.

Access Files on the OTG Flash Drive: Once the flash drive is connected, you can access its contents through your device's file manager or storage settings. You can view, copy, move, or delete files as needed.

Transfer Files: To transfer files between your mobile device and the OTG flash drive, select the files you want to transfer and move them to the appropriate location on the flash drive.

Eject the OTG Flash Drive: When you're finished using the OTG flash drive, safely eject it from your device to avoid data loss or corruption.

64GB

32GB

16GB

8GB

4GB



USB-61

4 in 1: Multifunction USB Pen. Multifunction Pen which includes a USB Flash Drive, Phone holder, Screen Cleaner. Equipped with a Schneider German Refill.

140 x 12 mm

Screen Printing, UV Printing Laser Markings

PROMOTIONAL STATIONERIES

In today's fast-paced and digital world, promotional stationery remains a powerful tool for businesses to leave a lasting impression on clients and customers. From branded pens and notebooks to desk accessories, promotional stationery not only serves as a practical tool but also effectively advertises a company's brand and message





maxema®

promotional
writing
instruments



Made
in Italy

—

Prodotto
in Italia

—

Fabriqué
en Italie

—

Fabricado
en Italia

An Italian Heart

Precision design, meticulous engineering, constant research and testing, selection of the best materials. In short: a love for beautiful objects and care for the environment. This is what an Italian-made product means for Maxema.

More than just a pen

Those who know us are well aware that our pens are much more than just plastic. We have been working in Italy for two generations alongside people we trust and with whom we love to design top quality writing implements. Each Maxema pen is created from the desire to take care of the environment and our customers, with safe, reliable and durable materials. Our mission? To support your projects and help you, wherever you may be in the world, to tell your story and leave a lasting message.

Imprint your brand

Once assembled, the pen is ready to be “dressed” with a brand or message, choosing the most suitable combinations between finishes, colors and printing techniques. At the end of the process, the pen is finally ready to bring its precious message: your image.







W BK

MAX-MDI-MM1

Maxema Mood Metal. Retractable with return spring, metal push-button, barrel and tip, clip made of non-toxic, highly resistant ABS plastic, "Parker type" refill, Blue Ink.

 142 x 11 mm

 **UV Printing, Screen Printing, Laser Markings.**



W BK

MAX-MDI-MM4

Maxema Mood Metal. Retractable with return spring, metal push-button, barrel and tip, clip made of non-toxic, highly resistant ABS plastic, "Parker type" refill, Blue Ink.

 142 x 11 mm

 **UV Printing, Screen Printing, Laser Markings.**



W BK

MAX-MDI-MM2

Maxema Mood Metal. Retractable with return spring, metal push-button, barrel and tip, clip made of non-toxic, highly resistant ABS plastic, "Parker type" refill, Blue Ink.

 142 x 11 mm

 **UV Printing, Screen Printing, Laser Markings.**



W BK

MAX-MD1-CM2

Maxema Mood. Retractable with return spring, metal push-button and tip, Clip & barrel made of non-toxic, highly resistant ABS plastic, equipped with Jumbo refill, Blue Ink.

 142 x 11 mm

 **UV Printing, Screen Printing**



MAX-MD1-CM3

Maxema Mood. Retractable with return spring, metal push-button and tip, Clip & barrel made of non-toxic, highly resistant ABS plastic, equipped with Jumbo refill, Blue Ink.

 142 x 11 mm

 **UV Printing, Screen Printing**



MAX-D1-BCR

Maxema Dot. Retractable with return spring, made of non-toxic, highly resistant ABS plastic, galvanic process used to chrome ABS push-button, Jumbo refill, Blue ink.

 142 x 11 mm

 **UV Printing, Screen Printing**



Maxema Antibacterial: design and safety

Take care of yourself even when you write: the plastic we use on our Antibacterial collection prevents bacteria from settling on pen surfaces and passing from one hand to the other.

Why choose Maxema Antibacterial Pen?



The plastic used is antibacterial

Certified antimicrobial additive releases silver ions and prevents bacteria from settling on the surfaces of the pen.



Bacteria: up to 99,99% less

Laboratory tests have shown that up to 99,99% of the bacteria on the pen are destroyed.



We Care about your health

Some bacteria can cause disease and infections: make your life still safer, even when you write.



06 10 76 87 19 21 58 07

MAX-TA2-C-AB-RE

Maxema - Recycled & Antibacterial. Twist-action, recycled plastic derived from post-consumer products with certified antimicrobial additive, Glossy finish, Jumbo refill, Blue Ink.

 140 x 11 mm

 UV Printing, Screen Printing



MAX-F2P-C-AB-01

Maxema Flow Pure Antibacterial. Twist-action, Made of non-toxic, highly resistant ABS plastic, Glossy textured barrel, Jumbo refill, Blue Ink.

 143 x 11 mm

 UV Printing, Screen Printing



MAX-Z1-C-AB-01

Maxema Zink Antibacterial. Twist-action, Made of non-toxic, highly resistant ABS plastic, Glossy textured barrel, Jumbo refill, Blue Ink.

 148 x 11 mm

 UV Printing, Screen Printing



MAX-B500-C-AB-01

Maxema Bay Antibacterial. Twist-action, Made of non-toxic, highly resistant ABS plastic, Glossy textured barrel, Jumbo refill, Blue Ink.

 135 x 12 mm

 UV Printing, Screen Printing



MAX-D1-MATT-CB-AB-01

Maxema Dot Antibacterial. Retractable with return spring, made of non-toxic, highly resistant ABS plastic, push-button, Jumbo refill, Blue ink.

 142 x 11 mm

 UV Printing, Screen Printing



An aerial photograph showing a large concrete dam with multiple arches, situated in a lush green forest. The dam is surrounded by dense trees, and a body of water is visible behind it. The sky is clear, and the overall scene is bright and natural.

RECYCLED PLASTIC PENS

Being Eco Friendly is a Way of Life.

For our recycled plastic pens we use materials of European origin that are 100% derived from postconsumer products.

When appropriately treated, they guarantee high quality plastics, certified and compliant with RoHS and REACH regulations. The production process consists of collecting WEEE material (waste electrical and electronic equipment), carefully separating the plastic from metal, glass and ceramic residues, and turning it into granulate material. This is how the Recycled line is made.

A large, stylized, dark green letter 'M' logo with rounded corners and a thick outline, set against a dark green background.

maxema®

Recycled Collection

Change is a choice and it depends on each of us.
To change means to choose responsible, sustainable consumption that prefers quality to quantity, better still if the raw materials come from recovery chains

A landscape photograph of a mountain range. The foreground is filled with trees with vibrant autumn foliage in shades of orange and yellow. In the background, there are snow-capped mountain peaks under a cloudy sky.

**Choose Better.
Make it last.**

Who said good things don't last? At Maxema, we do everything we can to make our pens live for as long as possible. A Maxema pen loves nature: the longer it lasts, the less it pollutes. And, since one life seemed too short for us, we have created a new line in recycled plastic, beautiful to look at and even more environmentally friendly

 POST-CONSUMER RECYCLED PLASTIC



MAX-F2P-MATT-CB-RE

Maxema Flow Pure - Recycled. Twist-action, Made of non-toxic, highly resistant ABS plastic, Recycled plastic matte textured barrel, Jumbo refill, Blue Ink.

 142 x 12 mm

 UV Printing, Screen Printing

 POST-CONSUMER RECYCLED PLASTIC

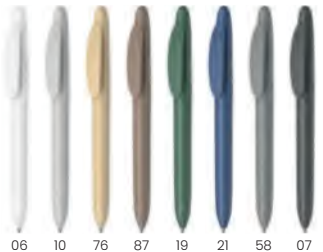

MAX-IC8-MATT-RE

Maxema Icon Pure - Recycled. Twist-action, Made of non-toxic, highly resistant ABS plastic, Recycled plastic matte textured barrel, Jumbo refill, Blue Ink.

 138 x 15 mm

 UV Printing, Screen Printing

 POST-CONSUMER RECYCLED PLASTIC



MAX-B500-MATT-RE

Maxema Bay - Recycled. Twist-action, Made of non-toxic, highly resistant ABS plastic, Recycled plastic matte textured barrel, Jumbo refill, Blue Ink.

 135 x 12 mm

 UV Printing, Screen Printing

 POST-CONSUMER RECYCLED PLASTIC



MAX-D1-MATT-RE

Maxema Dot - Recycled. Push-button mechanism, Made of non-toxic, highly resistant ABS plastic, Recycled plastic matte textured barrel, Jumbo refill, Blue Ink.

 142 x 11 mm

 UV Printing, Screen Printing

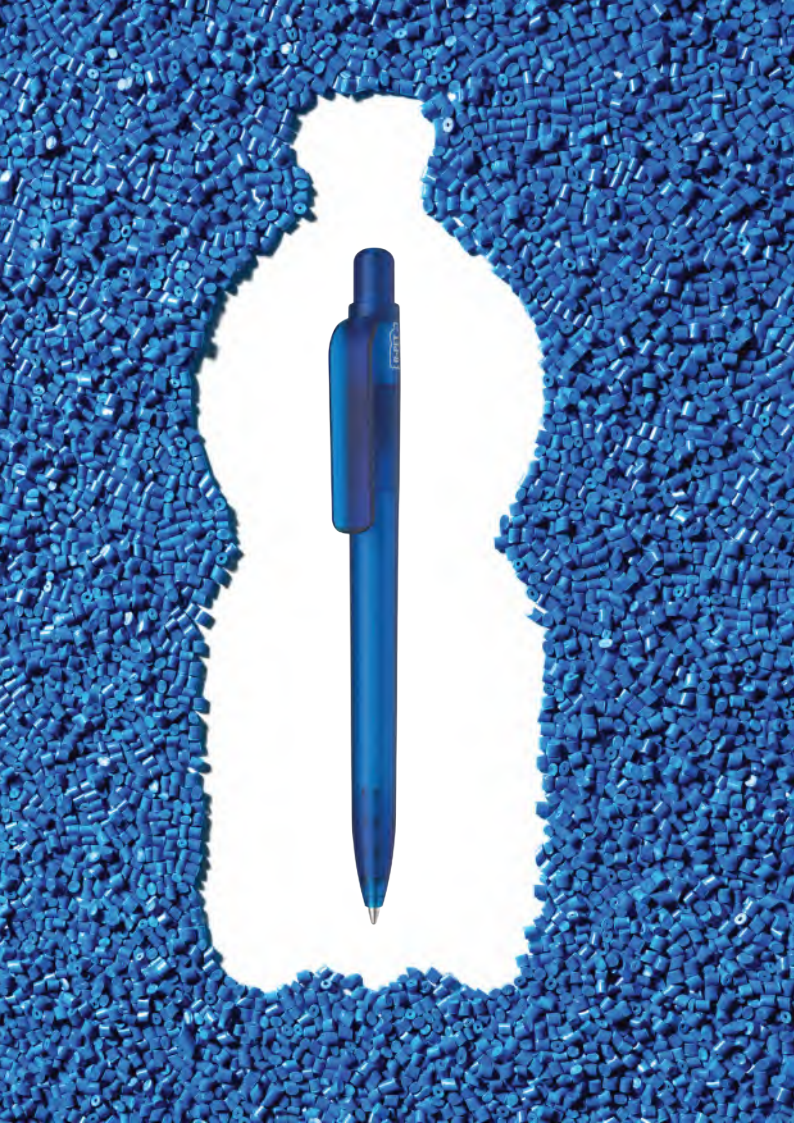

Message from a Bottle.

Kind is made of certified R-PET. This material is obtained by gathering and recycling PET, the most commonly used polyester in the production of soft-drink bottles.

R-PET is made of recycled plastic and contributes to reducing the environmental footprint. Studies show that, apart from combating the accumulation of plastic waste, recycling 1kg of R-PET is equivalent to reducing CO2 emissions by 3kg



39 53 45 49 44 32 50

Kind

Created to write change.
Transparent is cool!

MAX-K1-FROST

Maxema Kind. Push-button, Transparent colours with Matte textured finish, Made from RPET material. Jumbo refill, Blue Ink (Black optional).

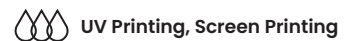
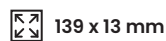



Zink

Solid, sturdy architecture for a profile of geometric precision.

MAX-ZI-C

Maxema Zink. Twist-action, Made of non-toxic, highly resistant ABS plastic, Glossy textured barrel, Jumbo refill, Blue Ink (Black optional).

 148 x 11 mm

 UV Printing, Screen Printing



Bay

Delicately refined matt finish in 22 colours.

MAX-BM

Maxema Bay. Twist-action, Made of non-toxic, highly resistant ABS plastic, Matte textured barrel, Jumbo refill, Blue Ink (Black optional).

 135 x 12 mm

 UV Printing, Screen Printing





Flow Pure

All the expressive force of colour in a monochrome version.

MAX-F2P-MATT

Maxema Flow Pure. Twist-action, Made of non-toxic, highly resistant ABS plastic, Matte textured barrel, Jumbo refill, Blue Ink.

 142 x 12 mm

 UV Printing, Screen Printing

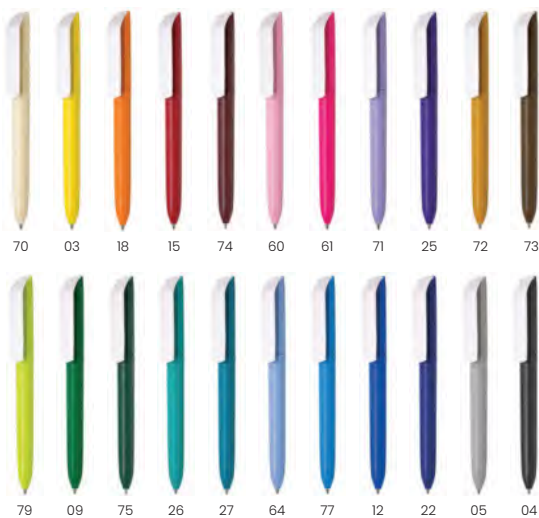

Flow Pure

Matte finish and white clip for maximum freedom of personalisation.

MAX-F2P-MATT-CB

Maxema Flow Pure. Twist-action, Made of non-toxic, highly resistant ABS plastic, Matte textured barrel, Jumbo refill, Blue Ink.

 142 x 12 mm

 UV Printing, Screen Printing



01 03 18 15 74 60 61 71 25 73 79 09



75 26 27 64 77 12 22 05 04

Dot

A pen that reveals its originality in its details.

MAX-D1-GOM-W

Maxema Dot. Retractable with return spring. Made of non-toxic, highly resistant ABS plastic, galvanic process used to chrome ABS push-button, Jumbo refill, Blue Ink.

 142 x 11 mm

 **UV Printing, Screen Printing**



UAE
Kuwait
Oman
KSA / Pakistan / Nigeria
Qatar
Bahrain
Iran
Iraq
India
Kenya

Ethic

Designed to outlast passing fashions, like the message it conveys.

MAX-ET-FLAG

Maxema Ethic. Twist-action, Made of non-toxic, highly resistant ABS plastic, galvanic process used to chrome tip & clip. Glossy textured barrel, Jumbo refill, Blue Ink.

 139 x 11 mm

 **UV Printing, Screen Printing**

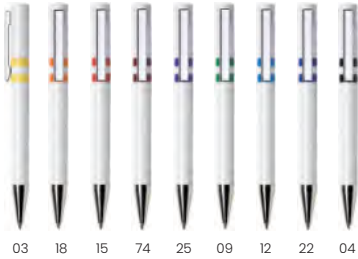

03 18 15 74 25 09 12 22 04

MAX-ET-B

Maxema Ethic. Twist-action, Made of non-toxic, highly resistant ABS plastic, galvanic process used to chrome tip & clip. Glossy textured barrel, Jumbo refill, Blue Ink.

 139 x 11 mm

 **UV Printing, Screen Printing**



03 18 15 74 09 12 22 04

MAX-ET-BC

Maxema Ethic. Twist-action, Made of non-toxic, highly resistant ABS plastic, galvanic process used to chrome tip & clip. Glossy textured barrel, Jumbo refill, Blue Ink.

 139 x 11 mm

 **UV Printing, Screen Printing**

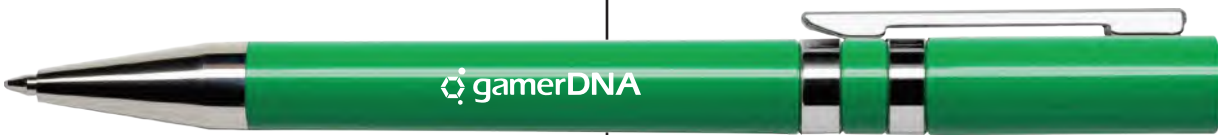

01 03 18 15 74 09 12 22 04

MAX-ET-CCR

Maxema Ethic. Twist-action, Made of non-toxic, highly resistant ABS plastic, galvanic process used to chrome tip & clip. Glossy textured barrel, Jumbo refill, Blue Ink.

 139 x 11 mm

 **UV Printing, Screen Printing**



PNN103-WHT

White Plastic Pen. Push-button function, glossy finish with wide clip design. Ballpoint

 140 x 13 mm

 Screen Printing, UV Printing



063

Branded Promotional Plastic Pens. They were made of 100% authentic, incredibly durable plastic with shiny metallic finish parts.

 140 x 13 mm

 UV Printing, Screen Printing



062

Branded Promotional Plastic Pens. They were made of 100% authentic, incredibly durable plastic with shiny metallic finish parts.

 140 x 13 mm

 UV Printing, Screen Printing



W BK R BL GR



060

Prism Design Plastic Pens. This pen has a barrel and tip made of vibrant plastic. Five distinct colors are available for this barrel.

 140 x 11 mm

 UV Printing, Screen Printing



W BK OR R SBL DBL GR



061

Twisted Design Plastic Pens. Unorthodox design branded pens made of plastic are innovative and of great quality.

 146 x 12 mm

 UV Printing, Screen Printing



BK OR R BL GR



097

Promotional Plastic Pen. Made from sturdy plastic. Comes with a glossy white finish.

 147 x 11 mm

 UV Printing, Screen Printing

WRITING INSTRUMENTS

Promotional Metal Pens

The Power of Promotional Metal Pens for your Business Growth

In today's competitive market, businesses are constantly looking for innovative ways to stand out from the crowd and attract new customers.

One highly effective marketing tool that continues to gain popularity is promotional metal pens. These pens are not only practical and useful, but they also serve as a powerful branding tool that can help boost your business growth.

The Benefits of using Promotional Metal Pens

1. Professional Image
2. Long-Lasting Brand Exposure
3. Wide Reach



PN47

Metal Pen with Stylus. The upper barrel has a soft rubberized coating and textured grip design. Pen Type : Ball Point

 145 x 15 mm

 Laser Engraving, UV Printing



GY

BK

R

BL

GR



PN45

Aluminum Pens with Stylus. Elegant and fashionable. Light and simple to hold. Pen Type : Ball Point

 137 x 10 mm

 Laser Markings, Screen Printing



BK GY OR R BL DBL GR

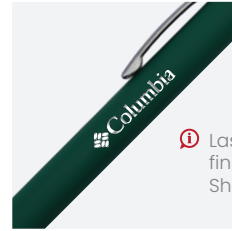

i Laser Engraving, finishing has a Shiny Silver Effect.

PN42

Metal Pen with Stylus. The entire barrel has a soft rubberized coating. Pen Type : Ball Point

 140 x 12 mm

 Laser Engraving



GL OR R BL GR



i Laser Engraving, finishing matches the colour of your stylus rubber tip.

PN43

Metal Pen with Stylus. Fashionable rubberized finish. Pen Type : Ball Point

 141 x 10 mm

 Laser Engraving



GL BK R BL GR

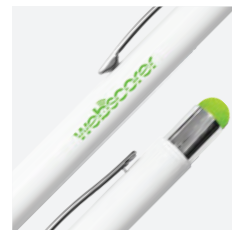

i Laser Engraving, finishing matches the colour of your stylus rubber tip.

PN44

Metal Pen with Stylus. This pen has a white shiny metallic barrel. Pen Type : Ball Point

 141 x 10 mm

 Laser Engraving, UV Printing



SL DG BK W R BL



PN20

Slim Metal Pens with Stylus. This pen has a stylish shiny appearance. Pen Type : Ball Point

 135 x 8 mm

 Screen Printing, UV Printing
Laser Markings



S BK BL R GRY GRE



PN27

Rubberized Metal Pen with Stylus. Twist-action has a silver chrome ring in the middle and stylus part. Pen Type : Ball Point

 143 x 13 mm

 Laser Engraving (Shiny Silver effect)



W G BK BL R



PN40

Stylish Metal Roller Pens. Chrome clip and accessories. Stunning and luxurious design. Pen Type : Roller Pen

 140 x 13 mm

 Screen Printing, UV Printing
Laser Markings



W BK

073

High-quality Metal Pen. Shiny exterior of top part of the structure, Grip made from rubberized material.



138 x 12 mm



Screen Printing, UV Printing, Laser Markings



W BK

PN03

High-quality Metal Pen. Pens made of premium metal are lavish and stylish. Matte finish body



140 x 15 mm



Black Pen : Screen Printing, Laser Markings

White Pen : UV Printing



W BK

PN04

High-quality Metal Pen. made of high-grade metal are of outstanding quality and have a fashionable style.



140 x 17 mm



Black Pen : Laser Engraving (Shiny Silver Effect)

White Pen : UV Printing



W BK

PN19

Crystal Pen with Stylus. The crystal component creates a glossy sheen, making it more fashionable.



145 x 11 mm



Screen Printing, UV Printing, Laser Markings



PN30

Full Chrome Metal Pen. The entire pen has a full chrome finish. Shiny, fashionable design.

 137 x 11 mm

 Laser Markings



W BR

PN26

Metal Pen with Stylus & LED Light. 3-in-1 function. Composed of metal. Elegant and fashionable.

 130 x 15 mm

 Screen Printing, UV Printing, Laser Markings

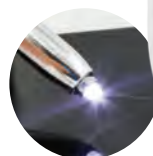

Tips for Using Promotional Metal Pens Effectively.

Choose a high-quality pen: Investing in a quality metal pen will ensure that your promotional item is well-received and reflects positively on your brand.

Personalize your pens: Add your company logo, contact details, or a motivational message to make your promotional metal pens stand out.

Distribute strategically: Hand out your promotional metal pens at events, trade shows, or as gifts to valued customers to maximize their impact.

Follow up: After distributing your pens, follow up with customers to see how they are enjoying their new pen and remind them of your products or services.



S G

PN37

Rubberized Black Metal Pen with Silver or Gold clip. Laser engraving shows a shiny effect of your branding.

 140 x 12 mm

 Laser Engraving (Shiny Silver or Gold Effect)

WRITING INSTRUMENTS

Eco-friendly Writing Instruments

Writing Instruments Made from Cork Materials

Cork material is a natural, renewable, and sustainable material derived from the bark of the cork oak tree (*quercus suber*), which is native to the mediterranean region. cork is a unique and versatile material that has been used for centuries



071

Wheat Straw and Cork Pens. An eco-friendly ballpoint pen with a click action mechanism

 140 x 12 mm

 Screen Printing, UV Printing



PN70-CO

Twist Action Metal Pen in Chrome and Cork Barrel. Includes and packed in a Cork Box.

 Pen : 140 x 15 mm
Box : 180 x 55 mm

 Screen Printing, UV Printing, Laser Markings



081

Cork Pens with Stylus. Eco-friendly design with a chrome tip for elegant and fashionable look.

 120 x 12 mm

 Screen Printing, UV Printing

MADE FROM RECYCLED MATERIALS



Made from Recycled Aluminum materials. Package of Ballpen & Mechanical Pencil.



PN-S10

Recycled Aluminum Pen & Pencil Set. Packed in Kraft paper box.

 140 x 10 mm

 Screen Printing, UV Printing



PN58-RSS

Recycled Stainless Steel Metal Pen. Push Button Mechanism. Sleek and contemporary look.

 140 x 12 mm

 Screen Printing, Laser Engraving



PN59-GRY

RPET Fabric Metal Pen. Twist-action mechanism, with metal chrome cap, clip, and tip.

 130 x 14 mm

 Laser Markings



W GY BK BL DBL GR R

PN46

Ballpoint push-button pens with a matte aluminum barrel, a clip with a gunmetal finish, and a bamboo grip.

142 x 10 mm

Screen Printing, UV Printing
Laser Markings.

Writing Instruments Made from Bamboo Materials

In recent years, there has been a growing trend towards eco-friendly and sustainable products. One such product that is gaining popularity is bamboo writing instruments. These pens and pencils are not only stylish and functional but also environmentally friendly. In this article, we will explore the benefits of using bamboo writing instruments.



PN61-BM

A combination of Chrome and Bamboo, These Pens are packed in a Bamboo Tube box with chromed cap.

Pen : 137 x 13 mm
Case : 160 x 25

Screen Printing,
UV Printing,
Laser Engraving,
Laser Markings



EFP-100

Bamboo Pens with Stylus. push-button on stylus. Chrome finish on tip and clip.

140 x 12 mm

Screen Printing,
UV Printing,
Laser Engraving



SL

G

082

Bamboo Pen with Silver/Gold Parts. Produced from sturdy bamboo fiber. Unique and fashionable piece.



140 x 12 mm



Screen Printing,
UV Printing,
Laser Engraving



PN60-BM

Bamboo Pen. Chromed Finish Upper Barrel & Bamboo Lower Barrel.



135 x 13 mm



Screen Printing,
UV Printing,
Laser Engraving,
Laser Markings



EFP-B2-BLK

Bamboo Pen with black tip and clip. Twist-action made from real bamboo material.



145 x 13 mm



UV Printing,
Laser Engraving



W

GR

068

Bamboo and Wheat Straw Pen. Push button mechanism. Sustainable and eco-friendly choice.



144 x 13 mm



Screen Printing,
UV Printing,
Laser Engraving



078

Coffee Pen. Push button mechanism, features a trendy textured finish. Made from sustainable coffee materials.



144 x 12 mm



Screen Printing, UV Printing



W BK BL GR

074

Wheat Straw Pen. The barrel of this pen is bright and has a fashionable feel.



140 x 12 mm



Screen Printing, UV Printing



A pencil that you can use forever. A special hardened stylus can replace over 100 pencils



EFP-101

Bamboo Inkless Pen with Eraser. Carbon Fiber tip. Trifold packing with sand paper for sharpening the tip of the pen.



140 x 12 mm



Screen Printing, UV Printing, Laser Engraving



GFK-04

Natural Color Pencil with Eraser, Simple & sleek. This pencil is crafted from original and eco-friendly wooden material.



170 x 10 mm



Screen Printing, UV Printing



GFK-05

Colored Pencils Set with Wooden Box. Made from wood, a sustainable resource. A colorful and imaginative item.

 208 x 40 x 30 mm

 Screen Printing,
UV Printing,
Laser Engraving



GFK-02

Promotional Crayons in Cardboard Box. A pencil stick of coloured chalk or wax, used for drawing. Set of 12 different colours.

 75 x 75 mm

 Screen Printing, UV Printing



GFK-03

Pencils in Cardboard Box. An art medium constructed of a narrow, pigmented core encased in a wooden case. Set of 12 colours.

 75 x 75 mm

 Screen Printing, UV Printing

Plant a Pencil

Rather than just throwing away your used pencil, make a difference meanwhile enjoying the growing.

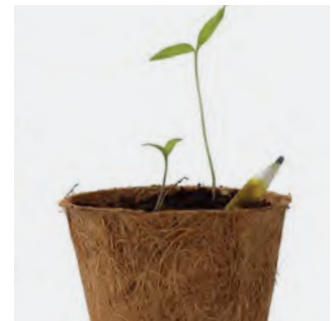

SPS-02

Plant-A-Pencil Kit. Pencil is made from 100% Recycled Papers. Includes a 1 Coir Pot and 1 Packet of Soil.



5 Seed Pencils - Tomato, Coriander, Chili, Mustard, Fenugreek.

135 x 200 x 70 mm

Digital Printing

Steps on how to use your Plantable Pencil / Pen

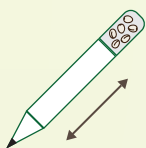

1 When Pencil is used and short.

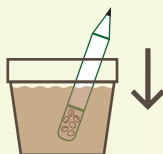

2 Gently push in cap at the bottom into the soil.

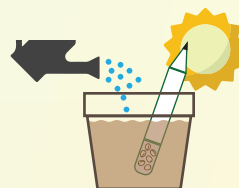

3 Add Water, Sun and Love. Remove the pencil after 3/4 days to allow seed to sprout better.



4 Watch it GROW!



SPS-03

Plant-A-Pencil. Pencil is made from 100% Recycled Papers. Eco-friendly and original product.



Pencil : 178 mm



Screen Printing, UV Printing

Plantable Pencil Benefits

Environmental Impact: By choosing our Plantable Pencil, you're actively participating in reforestation efforts and also reducing carbon emissions.

Educational Tool: Ideal for classrooms, workshops, or eco-awareness campaigns, these pencils serve as tangible reminders of the importance of sustainability.

Corporate Social Responsibility: Showcase your commitment to sustainability by incorporating these pencils into your corporate gifting, promotional events, or office supplies.

Community Engagement: Encourage community involvement by distributing these pencils at events, festivals, or as part of environmental initiatives.



Includes a Tomato Seed and a Recycled Packing.

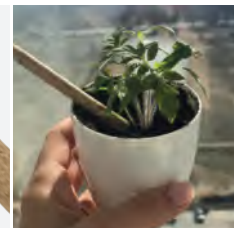

SPS-04

Plant-A-Pen. Pen is made from Recycled Papers. 0.7 mm Blue Refill Non-Drying Ink.



Packing : 135 x 200 x 70 mm
Pencil Length : 178 mm



Screen Printing, UV Printing
Digital Printing

Ghaf Tree

A remarkable tree native to the arid regions of the Middle East. This **Drought-resistant tree holds immense cultural, environmental, and economic significance**, making it a vital part of the ecosystem in these regions.

This products contains an actual Ghaf Seeds

Did you know?

The **Ghaf Tree** is known for its remarkable ability to thrive in harsh desert conditions with very little water. Its deep roots can reach down to find hidden water sources, allowing it to survive even in the driest of environments. This resilience makes the Ghaf Tree a symbol of strength and perseverance in the face of adversity.

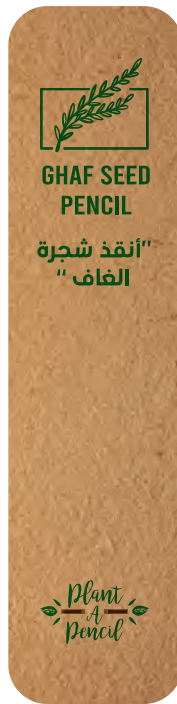

Plant your pencil in 4 easy steps

← Instruction

- TOO SHORT TO WRITE**
- PLANT**
Gently push the Green cap sideways at the bottom, into the soil.
- Remove the pencil after 3/4 days to allow th seeds to sprout better.
ADD WATER, SUN & LOVE
- WATCH IT GROW!**

The Ghaf is a drought-tolerant tree, which can remain green even in harsh desert environments
The Ghaf is the national tree of the UAE and can live up to 120 years!



SPS-05

Ghaf Seed Plantable Pencil in Single Pack Eco-Sleeve. Crafted with recycled materials and embedded with Ghaf tree seeds, this pencil embodies sustainability from its core.

45 x 190 mm

Screen Printing
UV Printing



This Kit contents



Soak soil coin in water for few minutes till it expands.



Place the soil in the pot, plant the seed



Keep the soil moist by regularly watering it.



Shower it with some sunlight and little love.

Planting Instructions



SPS-06

Plantable Kit with Soil Coins, GHAF Seeds, and Coir Pot. These are not only great for individuals interested in gardening or environmental conservation but also serve as educational tools to promote awareness about native plant species and their role in ecosystem health.

80 x 78 x 83 mm

Screen Printing, UV Printing

Turn this products back into a Plant

Step 1 SOAK ▶ Step 2 SOW IN POT ▶ Step 3 WATER ▶ Step 4 SUNLIGHT



SPS-07

A5 Size Plantable Marigold Seed Paper Bags. Tag label for planting instruction & Green Rope handle. Creative and eco-conscious solution for packaging needs.

175 x 225 x 125 mm Screen Printing

Seed Paper Material: These products are typically made from biodegradable paper embedded with marigold seeds. The paper is often crafted from recycled materials like post-consumer waste or cotton scraps.

Plantable: After use, the paper bags can be planted directly into the soil. The embedded seeds will germinate and grow into beautiful marigold flowers, adding color and life to the garden.

Environmentally Friendly: By using recycled materials and promoting plant growth, these bags help reduce waste and contribute to a healthier environment.



A Revolutionary Solution for Sustainable Living



SPS-08

Plantable Notepads B6 with Seed Covers & Spiral Binding. a fusion of sustainability and functionality! Crafted with care, this notepad with the promise of growth and renewal.

125 x 176 mm Screen Printing



These Products can grow a Marigold Plant, each material contains a seed.

Check product instruction and steps on how to grow your own Marigold.



SPS-09

Calendar made from plantable material, with Bamboo easel stand. Each of the 12 pages, plus the cover, is made from plantable seed paper embedded with marigold seeds. 100% Biodegradable.

110 x 30 x 165 mm UV DTF



PN33

Black Luxury Giftset. Includes a Black Roller Pen with an amazing design on clip and equipped with Scheider German Refill, combining a Elegant metal keychain.



133 x 12 mm (Pen)



Laser Markings, Screen Printing



PN15-R

Blossom Raphael Exclusive Pen. Glossy Black Barrel Design with Gold Plated Clip & Tip. Pen Type : Ball Point



141 x 14 mm



Laser Markings, Screen Printing



PN12 (2 pen - Package)

Dorniel Design Pen. Carbon Fiber Design Grip, Glossy Black Barrel with Chrome Clip & Tip. Pen Type : Roller & Ball Point, Ink Color : Black.



139 x 13 mm



Laser Markings, Screen Printing



PN50-BK / PN50-W

Dorniel Design Metal Pen. Chrome Luxury Design Pen with Dorniel Logo Engraved on Middle. Pen Type : Ball Point, Ink Color : Black.

 139 x 12 mm

 Screen Printing, UV Printing
Laser Markings



PN51-BK / PN51-W

Dorniel Design Metal Pen. Gold Plated Luxury Design Pen with Dorniel Logo Engraved on Middle. Pen Type : Ball Point, Ink Color : Black.

 139 x 12 mm

 Screen Printing, UV Printing
Laser Markings



PN52

Dorniel Metal Pen with UAE Traditions Design. Glossy Black Body with Engraving on Grip, Chrome Clip & Tip. Pen Type : Ball Point, Ink Color : Black.

 140 x 15 mm

 Laser Markings,
Screen Printing



LPB-05
Bamboo Pen Case with
Chromed Cap.



PPB-10
Bamboo Pen Box with
Velvet Interior.



LPB-04
Cork Pen Box with Velvet
Interior.



GB-PNWD02
Matte Finish Veneer Wood
Material Pen Box.



LPB-01
Leather Pen Packaging Box.
with white fabric interior.



LPB-02
Leather Pen Packaging Box.
with white fabric interior.



GB-PNWD01
Glossy black design hard wood
material with soft velvet interior.



PPB-03
Cardboard Pen Packaging
Box with felt material.



95
Velvet Pen Pouches.



PPB-02
Black Cardboard material box with velvet inside.



279
Plastic Pen Packing Box. Transparent Plastic Box to fully show your Pen.



PPB-05
Matte black pen packing box cardboard material.

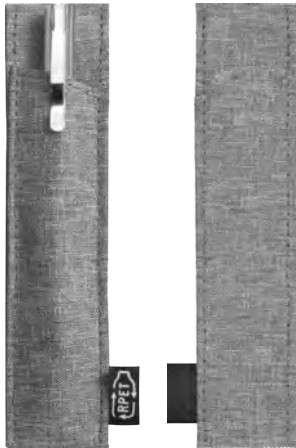

PNC-100-GRY

RPET fabric pen pouches with textured design. Simple and portable size with textured design.



Customized Pen Case

Print your own Design with Logo. The Pen case is made of FSC, 300g paper.



PNC

Felt material pen packaging pouch. The case is made of felt in Vivid colors.

STATIONERIES

Promotional Notebooks & Notepads



A5
size

CASTELLI
appeel



Made from Recycled Apple waste Material

There are several key benefits to using recycled apple waste material in packaging. One of the most significant advantages is that it helps to reduce the demand for virgin materials, such as plastic or paper, which require significant resources to produce. By using apple waste instead, we can conserve natural resources and reduce our carbon footprint.



GRY

BLK

DBL

MBAPP

Appeel A5 PU Notebooks with Elastic Band and Pen holder. Sustainably made from Apple Waste. 96 sheets of cream ruled paper with info page, ribbon bookmark & back pocket.

135 x 213 x 15 mm



Screen Printing, UV Printing
Debossing





Appeel A5 PU Notebooks and Recycled Maxema Pen Promotional Gift Set



Promotional Gift Set made from Recycled materials

Packing Box

Can be printed with single or full colour printing on the front cover



Appeel A5 Notebooks

Choose a color of our Notebook and have it printed with your brand or message.



Maxema Recycled Pen

Choose from our selection of Recycled Maxema Italian Pen and print your logo on its clip.





A5
size



MBRPET

A5 Size RPET fabric hard cover notebook with round bamboo trims and magnetic closure. 80 sheets - 70gsm cream ruled paper.

 160 x 210 x 18 mm

 Laser Engraving (bamboo)
Screen Printing.



A5
size



MB-D-BM

Fabric Cover Notebook with a touch of Bamboo material, Cover has a function of folding the front part to be used as a mobile stand. Has a Elastic band and a pen holder.

 140 x 210 x 17 mm

 Screen Printing, UV Printing.



A5 size



RNP-15

A5 Size Hard Cover Milk Paper and Cork Split Notebook. Made from Recycled Milk Carton and Cork material. 80 sheet cream color grid lined 80gsm milk paper.

145 x 210 x 15 mm Screen a, UV Printing.



Made from Recycled Milk Carton Material



1000 milk cartons instead of a tree. Used milk cartons are collected, sorted, processed and turned into paper, thus transforming waste into something useful.



A5 size

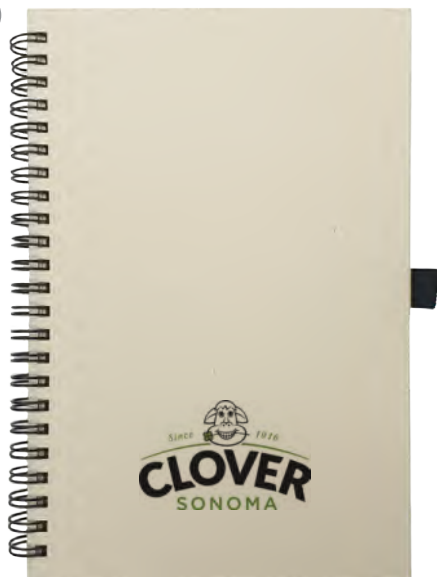

RNP-13

A5 Size Milk Paper Spiral Notebook. Made from Recycled milk carton material. 120g hard cardboard cover - 70 sheets - 80g inner pages.

140 x 207 mm Screen a, UV Printing.



A5 size

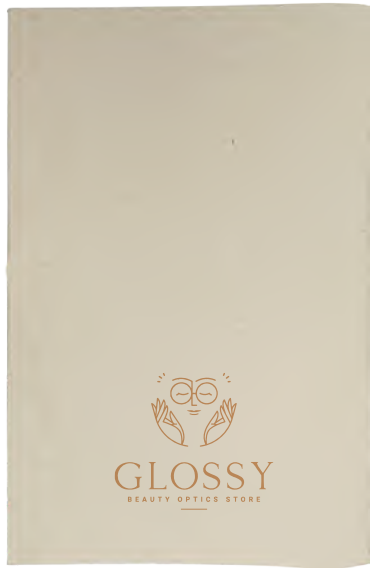

RNP-14

A5 Size Milk Paper Sewn Bound Notebook. Made from Recycled milk carton material. 30 sheets- 80g inner pages.

135 x 205 mm

Screen Printing, UV Printing.



A5 size

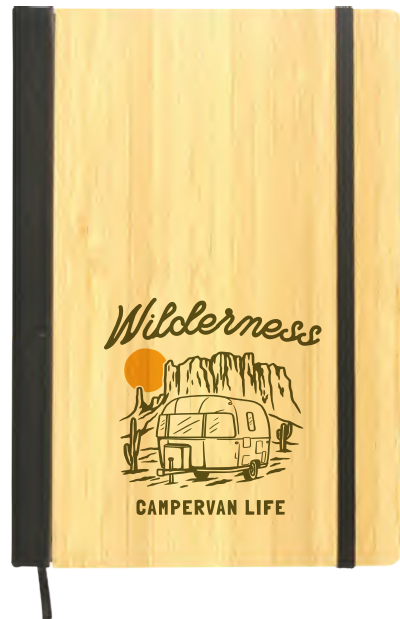

MBBM-BLK-A5

A5 Size Bamboo Notebook, 3mm natural bamboo front cover and black PU cover on back. 80 sheets - 70g kraft ruled paper with pen loop and ribbon page marker.

140 x 210 x 17 mm

Screen Printing, UV Printing.



A5 size

DORNIEL
DESIGNS

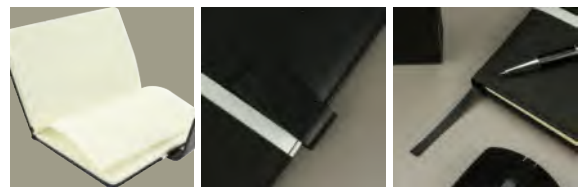

MBD-04

PU notebook with magnetic flap and page mark ribbon. 80g cream paper, 80 lined sheets round corner.

150 x 210 x 22 mm

Screen Printing, UV Printing, Debossing.



A5
size



MBD-02

PU notebook with front pocket, magnetic flap and page mark ribbon. 80g cream paper, 80 lined sheets round corner.

150 x 210 x 22 mm Screen Printing, UV Printing, Debossing.



A5
size



MBD-01

PU hardcover notebook with magnetic flap, pen holder and page mark ribbon. 80g cream paper, 80 lined sheets round corner.

150 x 210 x 22 mm Screen Printing, UV Printing, Debossing.



A5
size



MBD-03

A5 size Hard cover notebook in recycled leather material. 96 sheets - 70g Stone paper.

140 x 210 x 15 mm Screen Printing, UV Printing.



MBD-SF-BLK-A5

A5 Size Sadu Design Notebook with black PU lower part. Notebook has a pen holder, page mark ribbon, calendar and pocket. 95 pages cream ruled paper.

142 x 210 x 15 mm



Screen Printing, UV Printing, Debossing.



What is SADU Design?

Al Sadu is a traditional form of weaving practised by Bedouin women in rural communities of the United Arab Emirates to produce soft furnishings and decorative accessories.



**Also available in a
SADU Design Gift set**



A5 Size
Notebook
Sadu design



10,000mah
Light-up Wireless
Powerbank



500ml Glass
Bottle with
Sadu sleeve



A5 size

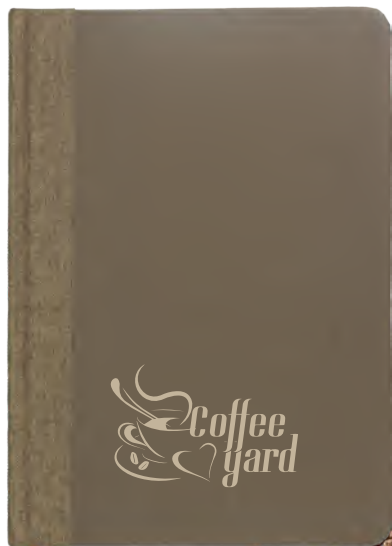

MBCOF-BRW-A5

A5 size Hard cover notebook in coffee viber material with matching coffee textured linen design. 96 sheets - 70g kraft ruled paper.



140 x 210 x 17 mm



Screen Printing, UV Printing



A5 size



MB-05-C

Cork Cover notebook. Hardcover Notebook with Black Elastic Band, Ribbon Bookmark & Pen Holder.



140 x 210 x 20 mm



Screen Printing, UV Printing.



A5 size

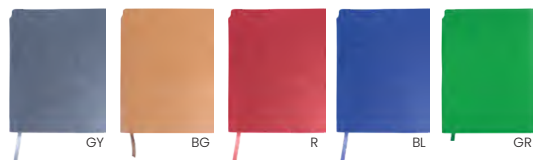

MB-05-CC

A5 Size Soft PU leather notebook in a solid color. Cover especially designed for debossing.



155 x 210 x 15 mm



Screen Printing, Debossing.



A5 size

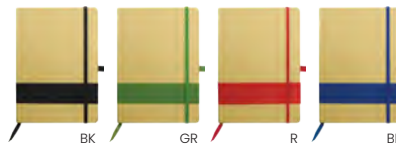

RNP-05

ECO Friendly Notebook with Pen holder. Made from hardboard with a colored stripe.

140 x 210 x 20 mm Screen Printing, UV Printing



A5 size



RNP-01

Recycled Notebook with Pen. Made of durable and recycled cardboard material.

160 x 210 mm Screen Printing

A5 size



MB-05-AB-W

A5 notebook with antibacterial soft PU cover and 96 lined pages (70 gr) with an elastic band closure.

146 x 210 x 15 mm Screen Printing, UV Printing, Debossing.



① Sides has the same color of its ribbon & pen holder.

A5
size

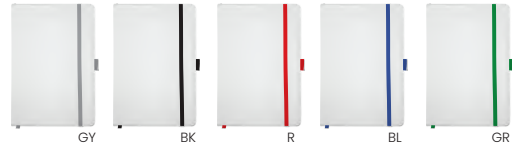

MB-05-WW

A5 Size PU Leather Notebook with Elastic Band, Pen Holder.

② 140 x 210 x 15 mm



Screen Printing, UV Printing, Debossing.



A5
size

USB-MB

A5 Size PU Leather Notebook with Elastic Band, Pen Holder & USB Flash Drive. Available in Different Capacity.

② 146 x 210 x 15 mm



Screen Printing, UV Printing.



A6
size

MB-06

A6 Size PU Leather Notebook with Elastic Band, Pen Holder. Sides has the same color of the cover.

② 90 x 145 x 15 mm



Screen Printing, UV Printing



A5
size



MBA5PU

A5 Size PU Leather Notebook with Elastic Band & Pen Holder.
Available in 13 different colors



146 x 210 x 15 mm



Screen Printing, UV Printing
Debossing

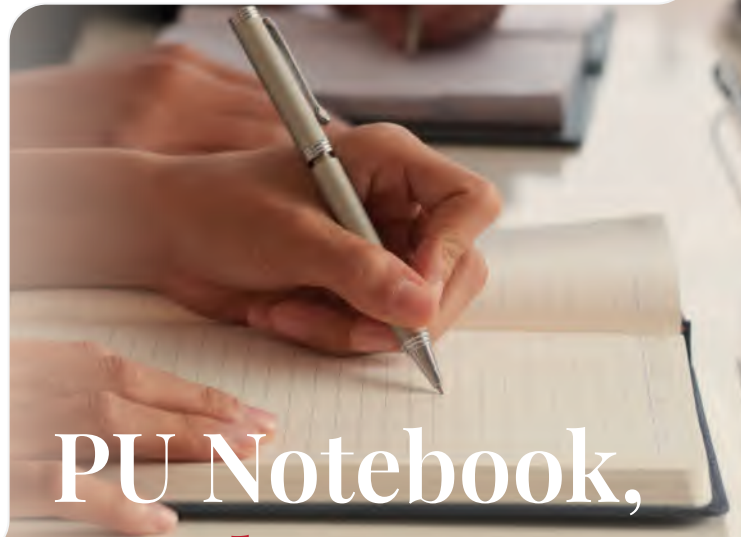

PU Notebook, Bigger the Better.

B5
size



MBB5PU

B5 Size PU Leather Notebook with Elastic Band & Pen Holder.
96Sheets/70g Lined Ivory Papers. 20mm Pen Loop. 8mm Ribbon
Bookmark. 6mm Rubber Band.



178 x 255 mm



Screen Printing, UV Printing
Debossing



SPS-08

Plantable Notepads B6 with Seed Covers & Spiral Binding, a fusion of sustainability and functionality! Crafted with care, this notepad with the promise of growth and renewal.

125 x 176 mm

Screen Printing



RNP-12

Bamboo Notebook with Pen. Made from Real wood with Recycled paper pages and a Recycled Pen.

150 x 175 mm

Screen Printing, UV Printing



RNP-06

Spiral notepad with recycled cardboard covers. Bold cover with a die-cut showing the sticky notes inside. Notepad sheets in a striped format with a cutted area for a eco friendly pen.

145 x 175 mm

Screen Printing, UV Printing

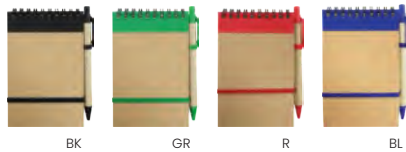

RNP-04

Recycled Spiral Notepad with soft-touch covers in resistant bicolour recycled cardboard. With elastic fastening on the cover & recycled pen.

90 x 140 mm

Screen Printing

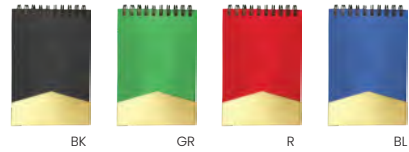

RNP-02

Recycled Spiral Notepad with Sticky notes and Pen in a magnetic flap. 3 different sizes of sticky notes in different colours.

90 x 150 mm

Screen Printing



MB-02

Leather box contains different types of sticky note and pad in different shapes and color.

130 x 102 x 28 mm

Screen Printing



RNP-03

Flap box that contains sheets of pad made from recycled material. Pencil in natural color body.

150 x 210 x 25 mm

Screen Printing, UV Printing.



RNP-08

Eco-friendly material notepad with a flap area showing a different color of sticky notes, includes a pen with a recycled paper barrel.

115 x 160 mm

Screen Printing, UV Printing.



RNP-10

Spiral Recycled notepad in cardboard covers with smiley cut out, showing a first layer with a sticky 2 types of note & below is the second layer with a 50 sheet notepad in striped format.

82 x 145 mm

Screen Printing, UV Printing.



RNP-09

Tri-fold writing set with strap closure. Notepad in the center, pocket & sticky notes on the right panel. Pen, ruler, pencils, sharpener and eraser on left panel.

150 x 210 x 25 mm

Screen Printing, UV Printing



BLK

NAT

RNP-20-NAT

Tri-Fold Notepad Kit. 80 Sheets / 70g lined kraft papers., 25 Sheets of yellow sticky notes. 25 Sheets 5C sticky flags, 12 cm Plastic ruler, 8 cm Eco ballpen (black ink)



105 x 155 x 17 mm



Screen Printing, UV Printing



RNP-16

Eco-Friendly Weekly Planner Kit. 100 Sheets/70g White Papers 25 Sheets 6Colors Sticky Flags, 10 pcs Paper Clip, Eco Ballpen (Black Ink).



250 x 200 x 15 mm



Screen Printing, UV Printing.



RNP-07

Cardboard box which flips open to reveal a handy sticky note set. Includes a block of multi coloured note paper, pad of yellow adhesive notes, five pads of different coloured adhesive flags and a pen / accessories holder.

90 x 90 mm

Screen Printing, UV Printing.



RNP-17

Foldable Memo Pad Sets with Stationery and Pen Holder. All-in-one tools that cater to those who want to keep their writing materials neatly arranged and easily accessible.

90 x 170 x 50 mm Screen Printing



RNP-19

Eco-friendly Portfolio with strap. Inside includes a writing plain pad, eco-friendly pen with holder, sticky notes and a pockets.

230 x 315 mm

Screen Printing, UV Printing





RNP-11

Notepad in wood like design with recycled cardboard pen. Ecological design with soft touch covers & elastic closure. 70 sheet with striped notepad, 25 large & 125 mini sticky notes.

105 x 155 x 23 mm Screen Printing



GFK-13

Eco-friendly Drawing Pad with Colored Pencils, Sharpener and Eraser. includes a 6 different colored pencils.

95 x 108 x 15 mm Screen Printing, UV Printing



GFK-10

Eco-friendly Drawing Pad with Colored Pencils. Booktype opening, includes 12 sheets printed pages & 38 blank pages and 12 colors of pencils.

95 x 108 x 15 mm Screen Printing, UV Printing.



Portfolio Folders

Why should you invest in portfolio folders?

Portfolio folders offer a myriad of benefits, including:

Organization: Say goodbye to clutter and hello to a well-structured system. Portfolio folders help you keep all your important documents in one place, making it easier to find what you need when you need it.

Professionalism: Impress your colleagues, clients, and professors with a sleek and organized portfolio folder. It shows that you are meticulous and detail-oriented, qualities that are highly valued in the professional world.

Protection: Keep your documents safe from spills, tears, and creases with a sturdy portfolio folder. Many folders come with protective features such as water-resistant materials and secure closures, ensuring that your papers remain in pristine condition.

Tips for Organizing Your Documents

- 1.) Sort your papers into categories before placing them in the folder.
- 2.) Use dividers or tabs to separate different sections.
- 3.) Label each section clearly for easy identification.
- 4.) Regularly review and update your documents to keep them current

In conclusion:

Portfolio folders are a practical and stylish solution for keeping your documents organized and secure. With a wide range of sizes, materials, and designs available, there's a folder to suit every need. By using portfolio folders effectively, you can streamline your workflow, protect your important papers, and add a touch of professionalism to your workspace.



MB-03

Leather Portfolio with Zipper and Calculator. Made of reliable leather material. Different compartments for holding your accessories. Creative and elegant item.

 335 x 255 mm

 Screen Printing

Portfolio folders are a game-changer for staying organized and professional in any setting. Whether you're a student, a business professional, or an artist, investing in a quality portfolio folder can make a world of difference.

DORNIEL
DESIGNS



► **Multi-function pockets**

- function includes a phone holder, phone stand, card holder, USB holder, pen holder,

► **8,000 mAh Powerbank**

► **50 sheet A4 size white ruled paper**

► **LED light-up logo on the cover**

► **Easy-carry handles**



FPB1-BLK

Zippered multi-function Portfolio with Light-up logo, includes a Wireless and built-in cables powerbank. Combines elegance and practicality with its sleek design.



265 x 335 x 37 mm



Laser Engraving (Light-up)
Screen Printing, UV DTF



PU

BF



MB-08

PU leather or Grey fabric. Magnetic Clasp with metal for laser markings. Mobile phone pocket in front, & inside. Elastic Mobile holder & Pen holder. Notebook with lined pages.

 175 x 235 x 25 mm

 Laser Engraving, Screen Printing

 **DORNIEL**
DESIGNS



BK

GY

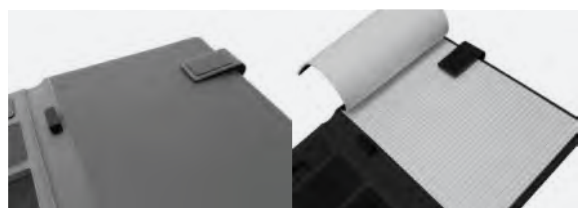

MB-07

PU leather & Black fabric Portfolio Folders with PU Magnetic Clasp with metal for laser markings. ID & Card Pockets, Mesh pocket for cables, Mobile Phone Strap & Holder.

 230 x 300 x 20 mm

 Screen Printing, Laser Markings

PROMOTIONAL BAGS

Simply looking to elevate your brand visibility, bags are an excellent choice. With a wide variety of styles, materials, and customizable options available, these bags can effectively showcase your brand while providing practical use for your target audience.



LARGE SELECTION OF

Promotional Cotton Bags

Cotton bags have gained popularity as a sustainable and eco-friendly alternative to plastic bags.

With growing concerns about environmental impact, cotton bags have become a preferred choice for shopping and carrying everyday essentials.

The **versatility, durability, and reusability** of cotton bags make them a practical option for consumers looking to reduce their environmental footprint.



CSB-08-RE

Recycled Cotton Tote Bags with long handle. sustainable and Eco-friendly material. 145 gsm.

 380 x 410 mm

 Heat transfer printing, Screen Printing.











ECO JUCO



CSB-01-RE

5 oz Recycled Cotton Bag with self fabric handle. Top quality, ECO-friendly, Perfect for retail & promotional use.

 380 x 420 mm

 Heat transfer printing,
Screen Printing.









ECO JUCO



CSB-01

5 oz - 100% Cotton bags with self fabric handle
Great for single or full colour printing.

 380 x 420 mm

 Heat transfer printing,
Screen Printing.









ECO JUCO



CSB-05

8 oz - 100% Cotton Bag with cotton webbing handle. Top quality, ECO-friendly. Can be branded with single or full colour printing.

 400 x 480 mm

 Heat transfer printing,
Screen Printing.



CSB-11

10 oz Recycled Cotton Canvas Bag with self fabric. Comfortable and sturdy strap. Can be branded with single or full colour printing.

380 x 415 mm

Heat transfer printing, Screen Printing.

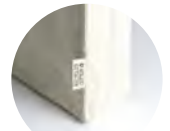

7.5 cm side width

CSB-13-RE-NAT

8 oz Recycled Canvas Bag with gusset, Self fabric handle. With a 13-inch long handle for carrying convenience.

375 x 410 x 75 mm

Heat transfer printing, Screen Printing.



8 cm side width



Long handle

CSB-13-RE-BLK

8 oz Black Recycled Canvas Bag with gusset. Self fabric handle.

380 x 420 x 80 mm

Heat transfer printing, Screen Printing.

LARGE SELECTION OF

Promotional Jute Bags



BLK

RED



BLU

GRE

JSB-17

Solid Color Promotional Jute Bag. Reinforced handle bags make them more durable and can hold more weight. Made to survive repeated usage, long-lasting and sturdy.



300 x 300 x 190 mm



Heat transfer printing, Screen Printing, DTF

Practical and eco-conscious alternative to plastic bags, jute bags are definitely worth considering.



FRONT

BACK

JSB-16

Jute Bags with 1 side cotton pocket and cotton padded handles. The cotton pocket suitable for single or full color printing.



300 x 300 x 15 mm



Heat transfer printing, Screen Printing.



JSB-18

10oz Laminated Cotton with natural jute gusset bag. The cotton sides are suitable for single or full color printing.



225 x 250 x 160 mm



Heat transfer printing, Screen Printing.



JSB-01

Jute Bag with cotton padded handle. Natural coloured jute bag with an attractive wooden lock button. These shopping bags are great for promoting a business or store.

 430 x 330 x 190 mm  Heat transfer printing, Screen Printing.



JSB-06

Jute Bag with bottom and padded handle. White sided area to highlight your single or full color logo. Reinforces at stress points for extra durability.

 400 x 330 x 150 mm  Heat transfer printing, Screen Printing.



JSB-07

Promotional Jute Bags. Square shaped bag in full Jute material. Flat handle. The horizontal design of these eco-friendly bags allows for carrying more stuff.

 300 x 300 x 190 mm  Heat transfer printing, Screen Printing.



JSB-08

Jute Bags with 8 oz canvas sides and cotton padded handles. Jute bag with cotton pocket suitable for single or full color printing.

 450 x 350 x 120 mm  Heat transfer printing, Screen Printing.



JSB-08-BLK

Jute Bag with Black Cotton Pocket and Handle. the perfect blend of sustainability and functionality. offers durability that withstands daily use while minimizing environmental impact.

 450 x 350 x 120 mm  Heat transfer printing, Screen Printing.



JSB-09

Jute Bag with 10 oz canvas sides and cotton webbing handle. Jute bag with cotton on side area to highlight your single or full color logo.

 280 x 340 x 140 mm  Heat transfer printing, Screen Printing.



JSB-11

Jute Bag with **10 oz** canvas sides and cotton webbing handle. Jute bag with cotton on side area to highlight your single or full color logo.

400 x 350 x 150 mm Heat transfer printing, Screen Printing.



JSB-14

JUCO Tote Beach Bags with Dual Straps. a great choice for anyone looking for a practical, durable, and stylish bag for their beach adventures.

480 x 350 x 135 mm Heat transfer printing, Screen Printing.



JSB-15

Laminated JUCO Beach Bags with Long Handles. features a gusset that allows it to stand on its own and maintains the bag's structure.

480 x 360 x 150 mm Heat transfer printing, Screen Printing.



JSB-12-W

White Laminated JUCO Bag with cotton padded handle. Made from 72% Jute and 28% Cotton, they are stronger and long-lasting, they have higher tensile strength.

 300 x 300 x 150 mm  Heat transfer printing, Screen Printing.



JSB-13

Promotional Jute Bags. Vertical shaped bag in full Jute material. White reinforced cotton handles with resistance up to 6kg weight. 100% biodegradable and favorable to the environment

 380 x 420 mm  Heat transfer printing, Screen Printing.



JSB-13-NAT

Cotton-like Jute Bags. Vertical shaped bag. White reinforced cotton handles with resistance up to 6kg weight. The finish that these bags have gives them a more refined feel.

 380 x 420 mm  Heat transfer printing, Screen Printing.



ECO JUCO



WHT BLK GRY GRE



BLU LBL RED ORE

CSB-09-RE

Recycled Cotton String Bag. Multi-function, Lightweight, easy to carry. Can be used as a bag in sports, yoga, travel or other trips.

370 x 410 mm

Screen Printing, Heattransfer



W BK LBL RBL DBL



GR PK R OR Y

SB-01

Promotional string bags are inexpensive, high-quality bags. These bags were constructed from polyester. They are powerful, long-lasting, and durable.

340 x 420 mm

Screen Printing, Heattransfer



ECO JUCO

CSB-10

Cotton Canvas Drawstring Bags, consisting of a cotton cord that goes through a seam around an opening & closing the bag. These bags are strong, long-lasting and durable.

380 x 420 mm

Screen Printing
Heattransfer



LARGE SELECTION OF

Promotional Backpacks



BLK

NAT

CSB-20

Cotton Backpack, 1 main compartment with garterized pocket on sides. Front pocket with flap cover and wooden buttons. Back padded straps.



400 x 470 x 130 mm



Screen Printing, Heattransfer



- High-density 600D waterproof Expandable Roll Top Backpack
- Adjustable buckle closure, padded strap, and front zipper pocket with reflector.
- Can fit up to a 15" laptop, and one open compartment inside.



SB-14

Backpack made from waterproof material with a roll top closure, front zippered pocket with reflector and back padded straps.



400 x 550 x 150 mm



Screen Printing



SB-04-GY

Promotional Backpack. 1 main zipper & 1 side zipper. Padded shoulder strap. Grey color exterior and black color interior.

400 x 450 x 170 mm Screen Printing, Heattransfer



SB-05

Dorniel Designs 15.6" Laptop Backpack , Front, Back, Side & Strap Pockets, Padded shoulder strap. Full Black with Leather design.

350 x 450 x 150 mm Heat Transfer



SB-13

Polyester backpack with zipper closure and front pockets. with back and padded shoulder straps, mesh pockets on sides, Padded compartment up to 15" laptops or tablets.

400 x 500 x 150 mm Screen Printing, Heattransfer



SB-20

Anti-theft Business backpack. USB output for charging. Laptops compartment up to 15" and tablets up to 10". Shoulder and backstraps with ergonomic padding.

350 x 450 x 110 mm Screen Printing



SB-17

Black Polyester Travel Backpack, includes a dedicated open compartment for laptops, a front zipper compartment, and a compression buckle for stability.

350 x 520 x 190 mm Screen Printing, Heattransfer



SB-03

Dorniel Designs 15.6" Grey coloured Laptop Backpack. Tablet Pocket, Padded shoulder strap, space for folders & files. 2 Zipper main zipper.

300 x 400 x 100 mm Screen Printing, Heattransfer



SB-16

Two-tone Backpack with zipper closure and padded straps. Two front pockets, mesh side pockets. 600D Polyester material.

400 x 500 x 150 mm Screen Printing, Heattransfer



SB-12

Two-tone Backpack with zipper closure, front right-side zipper pocket, and padded straps. 2 zipper pockets and a side mesh pocket. 600D Polyester material

390 x 590 x 175 mm Screen Printing, Heattransfer



SB-10

Colorful polyester backpacks. Front pocket with a zipper and one main zippered compartment. It features a holder and a shoulder padded strap that is movable.

310 x 410 x 120 mm Screen Printing, Heattransfer



SB-02

Polyester backpack with zipper closure and front pockets. with back and padded shoulder straps, mesh pockets on sides, Padded compartment up to 15" laptops or tablets.



340 x 420 mm



Screen Printing, Heattransfer



SB-09

Gym Bag. High Quality fabric with Grey interior, 1 zipper pocket, shoe compartment, mesh pocket for bottles, adjustable shoulder strap.



530 x 270 x 245 mm



Screen Printing, Heattransfer





SB-32

Triangular Grey textured Design Sling Crossbody Bag, Two front side zipper pocket with double zip main compartment and breathable padded mesh back and Shoulder Strap.

260 x 370 x 110 mm Screen Printing, Heattransfer



SB-31

Two-tone Slingbag with zipper closure, two front side zipper pocket, 1 main side compartment and adjustable strap.

230 x 390 x 100 mm Screen Printing, Heattransfer



SB-30

Black Sling Crossbody bag, Made from waterproof nylon material. 1 front side zipper pocket with 1 main compartment and breathable padded mesh back and Shoulder Strap.

220 x 340 x 120 mm Screen Printing, Heattransfer

SELECTION OF

Promotional Document Bags



SB-06

Dorniel Designs Document Bag. Interior with cushion protection for your Laptop & Tablets. Front & back zipper pocket, Padded shoulder strap.



350 x 260 x 70 mm



Screen Printing, Heattransfer



SB-07

Multifunction Bag. 2 front pockets. Inside paddings. Adjustable shoulder strap, with reinforcement. The bags were made from a textile material. They are therefore strong and elegant.



380 x 300 x 80 mm



Screen Printing, Heattransfer



DB

promotional document bag exudes grace, style, and refinement. These backpacks are fantastic for storing important items like laptops or documents.



370 x 270 mm



Screen Printing, Heattransfer



CB-BK

Promotional Cooler Bag. Great for summer time or just simply for any simple occasion. Zippered main compartment with insulation foam inside.

 200 x 180 x 130 mm  Screen Printing, Heattransfer



CB-02-BK

Promotional Cooler Backpack. Zippered main compartment with insulation foam interior. Adjustable shoulder strap.

 300 x 520 x 250 mm  Screen Printing, Heattransfer



SB-11

Reusable foldable shopping trolley bag, Great for outdoor or indoor essential daily bag. Smart collapsible design for saving room & effort. With two foldable wheels.

 400 x 600 x 135 mm  Screen Printing, Heattransfer



Promotional Pouches by: ECO JUCO



ECO JUCO



PCH-009-NAT-A5

Jute Pouches with pull strings. an environmentally friendly alternative to traditional plastic or paper packaging.

150 x 210 mm

Screen Printing, Heattransfer



ECO JUCO



PCH-009-NAT-A4

Jute Pouches with pull strings. an environmentally friendly alternative to traditional plastic or paper packaging.

210 x 300 mm

Screen Printing, Heattransfer



ECO JUCO



PCH-03

Drawstring Cotton Pouch Bag. Can be used as a gift or goodie bag when combining products or even simply to improve the presentation of a single gift or giveaway.

150 x 205 mm

Heat transfer printing, Screen Printing.



ECO JUCO



PCH-04

Drawstring Cotton Pouch Bag. Bag with one side Drawstring and Wooden Beads Design. Can be used as a gift or goodie bag when combining products.

190 x 245 mm

Heat transfer printing, Screen Printing.



PCH-005

6oz Cotton Zipper Pouch. Lightweight and Durable. Made from Natural Cotton (cream) and Recycled Cotton (black). Perfect for organizing and storing things.

210 x 160 mm

Heat transfer printing, Screen Printing.



PCH-006-NAT

8oz Natural Jute with cotton zipper pouch. Lightweight and spacious. Multipurpose, great used as cosmetics, toiletry, medicine or travel pouch.

200 x 150 x 60 mm

Heat transfer printing, Screen Printing.



PCH-007

Natural Jute Zipper Pouch for Organizing Storage. Sustainable and biodegradable material, and are a fantastic solution for eco-friendly alternatives to plastic or synthetic organizers.

225 x 155 mm

Heat transfer printing, Screen Printing.



ECO JUCO



PCH-008

6oz Cotton pouch with front zipper. Made from Natural Cotton & Recycled Cotton (black). Multipurpose - perfect for organizing or storing small things.

210 x 130 x 30 mm
Heat transfer printing, Screen Printing, DTF

ECO JUCO



PCH-01

Cotton canvas pouch with coloured bottom and matching zipper puller. Ideal for trade shows, exhibitions, seminars, gift bags, promotional souvenirs, and more!

220 x 160 mm
Heat transfer printing, Screen Printing.



GFK-01

Pencil Pouch. Non-woven pouch material with zipper. For variety of functions and events, personalized cases give amusement & portability. For single or multi-color printing.

210 x 115 mm
Sublimation, Screen Printing

300 gsm



SPS-07

A5 Size Plantable Marigold Seed Paper Bags. Tag label for planting instruction & Green Rope handle. Creative and eco-conscious solution for packaging needs.

175 x 225 x 125 mm
Screen Printing

LARGE SELECTION OF

Non-woven Promotional Bags

100
gsm

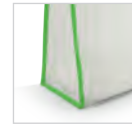

NW-1V
White & Green



NW-2V
White & Black



NW-3V
White & Red



NW-4V
White & Blue



NW-5V
Beige & Brown



NW-6V
Full White



NW-7V
Pink



NW-15V
Full Black

Vertical Non-woven Bags in a varied range of colors. With reinforced short handles and heat-sealing finish.



300 x 380 x 120 mm



Screen Printing.

100
gsm



NW-1H
White & Green



NW-2H
White & Black



NW-3H
White & Red



NW-4H
White & Blue



NW-5H
Beige & Brown



NW-6H
Full White



NW-8H
Full Pink



NW-11H
Orange & Yellow



NW-13H
Green



NW-15H
Full Black

Horizontal Non-woven Bags in a varied range of colors. With reinforced short handles and heat-sealing finish.



430 x 330 x 120 mm



Screen Printing.



NW-SUB-6V

White non-woven bag. Bio-degradable and eco-friendly. Lightweight and eye-catching appearance.

300 x 380 x 120 mm Sublimation



NW-SUB

White non-woven bag. Bio-degradable and eco-friendly. Lightweight and eye-catching appearance.

370 x 390 mm Sublimation (edge-to-edge printing)



NW-SUB-A4H
for Sublimation

NW-A4-BK
for Screen Printing

Horizontal Non-woven bag. Lightweight and durable. Water absorbent and chemical resistant. Biodegradable and usable.

325 x 250 x 120 mm (A4 Size)



NW-SUB-A5H
for Sublimation

NW-A5-BK
for Screen Printing

Vertical Non-woven bag. Lightweight and durable. Water absorbent and chemical resistant. Biodegradable and usable.

190 x 240 x 120 mm (A5 Size)

PROMOTIONAL DRINKWARES

These items have become a popular promotional item for businesses looking to expand their brand presence and attract customers. Among the variety of options available, promotional drinkwares such as personalized water bottles, coffee mugs and tea coasters are widely used by companies as they serve both functional and marketing purposes.



500 ml



Lanyard storage



Cup function



Long lanyard

TM-073

Double-wall Stainless Steel Vacuum Bottles with easy-to-carry lanyard handles and a drinking cup.

 74 x 255 mm

 Screen Printing, Laser Markings, Sublimation, UV DTF Printing, 360° UV Printing

Lanyards are fully customisable.

Can be printed with single or full color designs.



450 ml



WHT

BLU

BLK



TM-072

Double-wall Stainless Steel Vacuum Bottles with easy-to-carry handles and also acts as a phone holder.

 70 x 220 mm

 Screen Printing, Sublimation, UV DTF Printing, 360° UV Printing

1200 ml



WHT

BLK

BLU



TM-040

Double-wall Stainless Steel Vacuum Bottles with easy-to-carry handles and trendy Matt finish colors

 90 x 300 mm

 Screen Printing, Laser Markings, Sublimation, 360° UV Printing

500
ml



TM-070

Double-wall Stainless Steel Vacuum Bottles with PP flip lid and handle. Twisted trendy design for base body.

 78 x 270 mm

 Laser Markings, UV DTF Printing

BLK

WHT

500
ml



RECYCLED
STAINLESS STEEL





BLK

WHT

TM-071

Double-wall Recycled Stainless Steel Vacuum Bottles with easy-to-carry handles.

 70 x 260 mm

 Screen Printing, Laser Markings, Sublimation, 360° UV Printing



600 ml



BK

SL

W



TM-013

Double-wall stainless steel vacuum flask with Bamboo lid and easy-carry handle. Durable and long-lasting stainless steel material.

70 x 255 mm

Screen Printing, Sublimation, 360° UV Printing



500 ml



TM-015-BK

A Matte black texture double wall stainless steel bottle, Silver twist top lid holds a silicone ring to prevent leakage.

80 x 260 mm

Screen Printing, Laser Engraving

DORNIEL
DESIGNS

850 ml

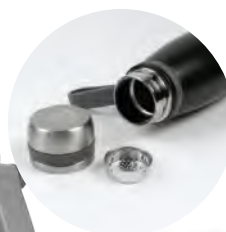

TM-041

Double-wall Stainless Steel Vacuum Bottles with easy-to-carry handle. Matt finish body, Spill proof lid & insulated feature.

80 x 260 mm

Screen Printing, Laser Markings, 360° UV Printing



BLK



WHT



500 ml



TM-043

Double-wall Vacuum Insulation Stainless Steel Bottles with Smart Temperature Display & Tea Infuser. Easy to grip slim design & ergonomic design.

 65 x 230 mm

 Screen Printing, UV Printing, Laser Engraving, DTF, 360° UV Printing



530 ml



TM-017-BK

Double-wall stainless steel and bamboo vacuum insulated flask. Black lid with a black handle and a removable tea infuser.

 75 x 285 mm

 Screen Printing, Laser Engraving, 360° UV Printing

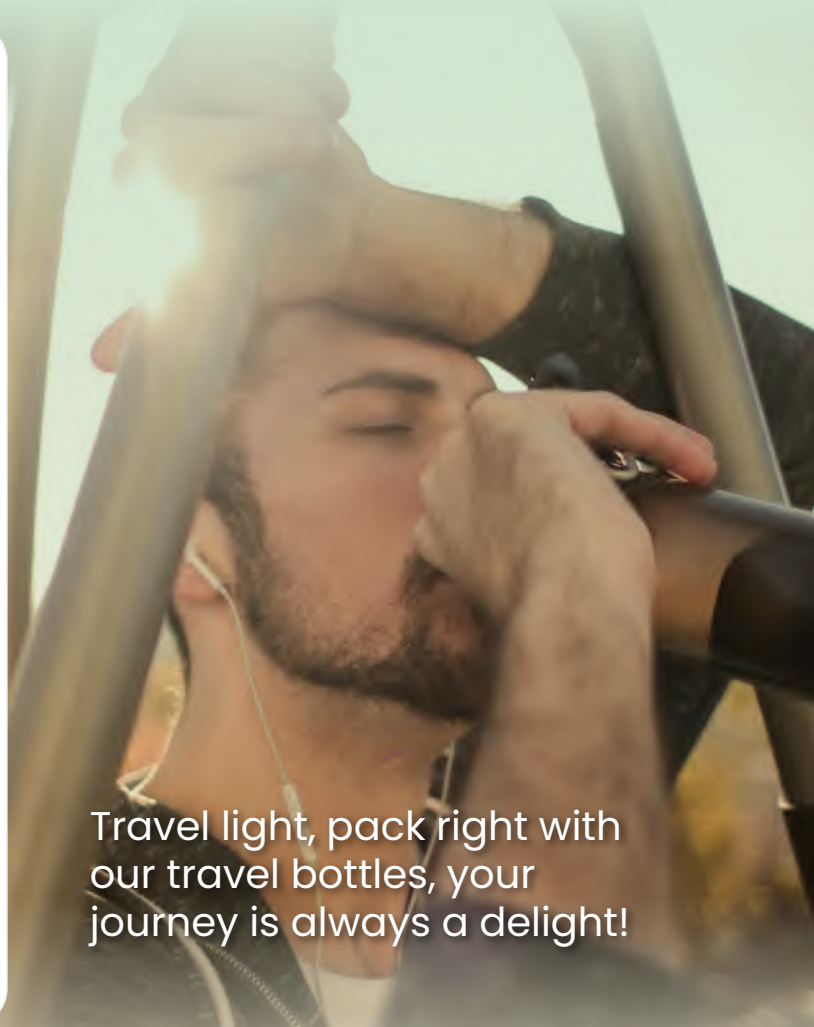

Travel light, pack right with our travel bottles, your journey is always a delight!



500 ml



TM-014

Double-wall in high borosilicate glass bottle and bamboo lid with tea infuser.

70 x 230 mm

Screen Printing, Laser Engraving, UV DTF



750 ml



TM-074

Double-wall Stainless Steel Bottles with easy-to-carry handle. Matt finish body, Spill proof lid & insulated feature.

78 x 275 mm

Screen Printing, UV Printing, Laser Engraving, 360° UV Printing



500 ml

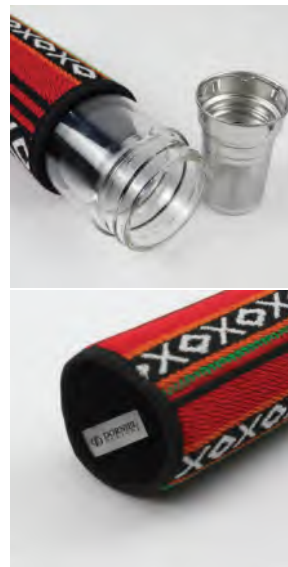

TM-036

Sadu Design Sleeve - Double wall in high borosilicate glass bottle and black lid with tea infuser.

70 x 260 mm

Screen Printing UV DTF



500 ml



TM-018
Bamboo Flask with Temp. Display. Thermos flask with filter, Made from bamboo & double wall stainless steel interior.

70 x 250 mm

Screen Printing, UV Printing, Laser Engraving, 360° UV Printing



450 ml



TM-011
Stainless Steel Bamboo Flask. Thermos flask with tea infuser, Made from bamboo & double wall stainless steel interior.

63 x 225 mm

Screen Printing, UV Printing, Laser Engraving, 360° UV Printing



430 ml



TM-012
Bamboo Flask. Made from bamboo & double wall stainless steel interior. Thermal bottle with a steel cap.

65 x 255 mm

Screen Printing, UV Printing, Laser Engraving, 360° UV Printing





500 ml



TM-032-BM

Bottle in combination of bamboo and glass materials. Screw on bamboo lid and an elegant, eco sleeve.

66 x 230 mm

Screen Printing, Heat transfer



1000 ml



TM-034-NAT

Clear glass water bottles with eco-friendly sleeve and bamboo lid. Lid has a handle for easy carry.

95 x 230 mm

Screen Printing, Heat Transfer, UV DTF



500 ml



TM-011-BK

Bamboo Flask, Double wall stainless steel flask with black lid with a black handle and a removable tea infuser.

65 x 235 mm

Screen Printing, Laser Engraving, 360° UV Printing

Reducing your carbon footprint. By investing in eco-friendly travel bottles, you can significantly cut down on the amount of plastic waste you generate while on the road.







750 ml



140
Single-wall Sports Bottle, Matte texture aluminum body with carabiner clip.

 73 x 260 mm

 Screen Printing, 360° UV Printing, Sublimation

W

BK

R

BL

GR



PREMIUM Quality
Soft-Touch
Cola Bottle



BLK-ST



BK



R



BL

500 ml



TM-009
Stainless Steel Travel Bottles. Durable and long-lasting material.

 70 x 265 mm

 Screen Printing, 360° UV Printing



800 ml



141-W
Single-wall Aluminum Bottle, screw cap with integrated handle.

 70 x 255 mm

 Screen Printing, UV Printing, Sublimation, 360° UV Printing



W





S

500 ml



144
Glossy Stainless Steel Travel Bottle. Lightweight and simple to transport.

 70 x 270 mm

 Screen Printing, UV Printing, Sublimation, 360° UV Printing



TM-048

Sports Glass Water Bottle with plastic cover and portable handle strap.

 72 x 77 x 206 mm

 Screen Printing, 360° UV Printing



TM-008

Glass Bottle with Sleeve. Stainless steel lid with handle. Lightweight and portable item.

 65 x 255 mm

 Screen Printing, Heat Transfer

WHT

BLK

RED

BLU

GRE



TM-002

Bottle with Fruit Infuser. Simply put in your fruits & you're good to go. Design comes with a foldable handle & nozzle.

 68 x 245 mm

 Screen Printing, UV Printing

W

R

BL

BK



800 ml



TM-047

Recycled PET Bottle with Stainless Steel Cap and secure cap keeper also can act as a portable handle.

 65 x 210 mm

 Screen Printing,
UV Printing,
360° UV Printing



550 ml

TM-033-CL

RPET Sports Bottle with String Handle. Made from Recycled materials.

 65 x 210 mm

 Screen Printing,
UV Printing



Stay Hydrated, Go the Extra Mile:
Your Perfect Companion in
Every Workout.

1000 ml



TM-037

Motivational time marked Bottle with straw. Perfect for measuring your daily water intake and reminding you to stay hydrated and drink enough water each day to meet scientifically recommended intake.

 78 x 283 mm

 Screen Printing, UV Printing



720 ml



CLR

BLK

GRE

BLU

OR

RED



TM-038

RPET Bottle with Cork base. Twist-off Lid & Handle. This Bottle provides an eco-friendly solution while maintaining durability.

 70 x 280 mm

 Screen Printing, UV Printing, DTF Printing, 360° UV Printing

LARGE SELECTION OF

Promotional Tumblers

Tumblers have become a popular choice for businesses looking to boost brand awareness and engage with their customers.

These versatile and practical products offer a unique way to showcase your brand while providing a useful item that people will use every day.



532 ml



TM-075

18 oz Double-wall Stainless Steel tumbler with rubber grip and a semi-transparent slide-lock lid.

 75 x 20 mm3

 Screen Printing, UV DTF, Laser Markings, 360° UV Printing



900 ml

WHT

BLK



TM-042

Stainless steel double-wall vacuum insulated tumbler with flip-straw Lid and carry handle.

 100 x 240 x 82 mm

 Screen Printing, UV Printing, Laser Engraving, 360° UV Printing



WHT



BLK



BLU



473 ml

TM-077

16 oz Double-wall Tumbler with lid. Matte finish texture. Stainless Steel outer material and PP for interior.



87 x 195 mm



Screen Printing, UV DTF Printing, 360° UV Printing



WHT



BLK

591 ml



TM-076

20oz Double-wall Stainless Steel Tumbler with spill proof slide-lock PP lid. 304SS outer and 201SS inner. Available in black and white.



88 x 94 x 190 mm



Screen Printing, Sublimation Laser Markings, UV DTF 360° UV Printing



510 ml



TM-039

Black Stainless Steel Tumbler with Lid and a Digital Temperature.



89 x 167 mm



Screen Printing



500 ml

TM-005

Double-Wall Travel Mugs with Clear Lid. Innovative and distinctive designs with an exterior wall made of tough AS plastic.

75 x 190 mm

Screen Printing, 360° UV Printing



450 ml



TM-016-BK

Double-wall Stainless Steel Travel Tumbler with Bamboo, Vacuum insulated and has a Transparent Plastic Lid.

85 x 185 mm

Screen Printing, UV Printing, Laser Engraving



450 ml



WHT

BLK



TM-010

Travel Tumbler with Cork Base, Vacuum insulated and has a Transparent Plastic Lid. Ideal for keeping your beverage hot or cold.

100 x 240 x 82 mm

Screen Printing, UV Printing, Laser Engraving, UV DTF, 360° UV Printing, Sublimation

TM-035-FRS
 Frosted Glass with Straw & Bamboo Lid. Made of high borosilicate material. Has a eco-friendly lid with silica gasket seal.

75 x 140 mm Screen Printing, Sublimation

TM-023-BM
 Travel Cup. Single wall tumbler in 65% PLA corn and 35% wheat straw with bamboo lid and cork grip. It is made from fermented plant starch which is free of toxics.

85 x 130 mm Laser Engraving on Lid

TM-020
 Wheat Straw Cup with Silicone lid and band. The lid is designed like a sip lid. As a result, you can use it to sip tea, coffee, and other beverages.

150 x 205 mm Screen Printing

TM-021
 Bamboo Fiber Cup with Silicone lid and band. The lid is designed like a sip lid. As a result, you can use it to sip tea, coffee, and other beverages.

150 x 205 mm Screen Printing

LARGE SELECTION OF

Promotional Ceramic Mugs

Ceramic mugs come in a wide range of colors, shapes, and designs, allowing you to express your personality and style through your drink-ware choice.

Whether you prefer a classic solid color mug or a whimsical patterned design, there is a ceramic mug out there to suit your taste.



295 ml

10 oz



MU-CE189

10 oz Glossy Finish Ceramic Sublimation Cup.

110 x 82 x 72 mm

Sublimation

325 ml

11 oz



MU-CE147B-WHT

White Sublimation Ceramic Mugs with white window-type carton packing box.

80 x 95 mm

Sublimation



325 ml

11 oz

147-D

White Ceramic Mugs. Durable, long-lasting, and strong ceramic material.

80 x 95 mm

Sublimation



440 ml

15 oz

148

White Glossy Finish Sublimation Ceramic Mug. Made of a robust and sturdy ceramic substance.

85 x 115 mm

Sublimation



295 ml
10 oz



MU-MR190

4pcs 10 oz Ceramic Cup Set with Metal Rack. This ceramic cups can stack-up to each other, perfect for compact usage.

108 x 110 x 285 mm Sublimation



355 ml
12 oz



MU-CE171

Matte texture ceramic mug with clay material in color tone on the base. Combining style with functionality for a touch of sophistication in every sip.

118 x 87 x 105 mm Sublimation



325 ml
11 oz

191

Ceramic Mug with a Heart-shaped Handle. White mug with glossy finish, Delivered in set of two mugs.

85 x 95 mm /mug

Sublimation

325
ml

11
oz



167-BK-M

Matte Black Color changing mugs, look simple enough at first glance. But pouring any hot drink into the heat sensitive glossy black ceramic mug reveals a special surprise.

 80 x 95 mm

 Sublimation



Original
Color

Pour in Hot Beverages
Changing Stage

Design
Revealed



590
ml

20
oz

149

White Ceramic Beer Mugs. Strong and artistic appearance since they are made of high-quality, long-lasting ceramic material.

 78 x 160 mm

 Sublimation



295
ml

10
oz

155

White Glossy Ceramic mug. Made of high-quality, long-lasting ceramic, giving them strength and dependability.

 70 x 105 mm

 Sublimation



325
ml

11
oz

169

White Glossy Ceramic Mug. Has a distinctive curved edges that make them look different and more innovative than other mugs.

 80 x 98 mm

 Sublimation

325 ml
11 oz



Optional Packaging Box

146N

Ceramic mug with a heart shaped handle & matching color of silicone cap to avoid leaks & non-slip silicone base.

 85 x 125 mm

 Sublimation

Capacity : 325 ml - 11oz

325 ml
11 oz



168

Two-Tone Ceramic Mug. Has an overall white construction with the exception of the interior and handle. Inventive and distinctive enough to catch people's eyes.

 85 x 185 mm

 Sublimation

325 ml
11 oz



170

Two-Tone Ceramic Mugs with Spoon. Durable and long-lasting ceramic material. Great for Sublimation printing for a colorful and vivid look.

 80 x 102 mm

 Sublimation

Let's dive into the world of promotional clear mugs and explore the possibilities for elevating your brand's visibility and impact.

Whether you're looking for a sleek and modern design or a classic and elegant style, there are clear mugs to suit every taste and need.



320
ml

11
oz



Printing
on Lid area



TM-030

Double-walled borosilicate glass travel cup with bamboo lid. Ideal for cold or hot liquids, with silicone insulation that facilitates the transport of the glass avoiding splashes.

130 x 85 x 120 mm



Screen Printing, UV Printing,
Laser Engraving



400
ml

13.5
oz



Printing
on Lid area



TM-031

Travel Cup is made from borosilicate glass, offering exceptional resistance & durability. Includes a polished bamboo lid & spoon, presented in cardboard box.

100 x 117 mm



Screen Printing, UV Printing,
Laser Engraving



385 ml

13 oz



151

Travel Mug made with ceramic material, and a touch of Cork material as base. Spill proof Clear lid.

88 x 110 mm

Screen Printing, UV DTF Sublimation



385 ml

13 oz



WHT

BLK

DBL



TM-024

Travel Mug made with ceramic material, and a touch of Bamboo material on the lid and handle.

80 x 110 mm

Screen Printing, UV Printing, Laser Engraving, Sublimation, UV DTF



385 ml

10 oz



TM-026

Bamboo & Stainless Steel Coffee Travel Mug with Handle and Lid. compact and eco-friendly. Features a bamboo exterior, a sturdy stainless steel interior, and a comfortable handle.

118 x 105 x 80 mm

Screen Printing, UV Printing, Laser Engraving, UV DTF

175-S

Glossy Finish Silver Sublimation Ceramic Mug.

325 ml 11 oz

80 x 98 mm

Sublimation

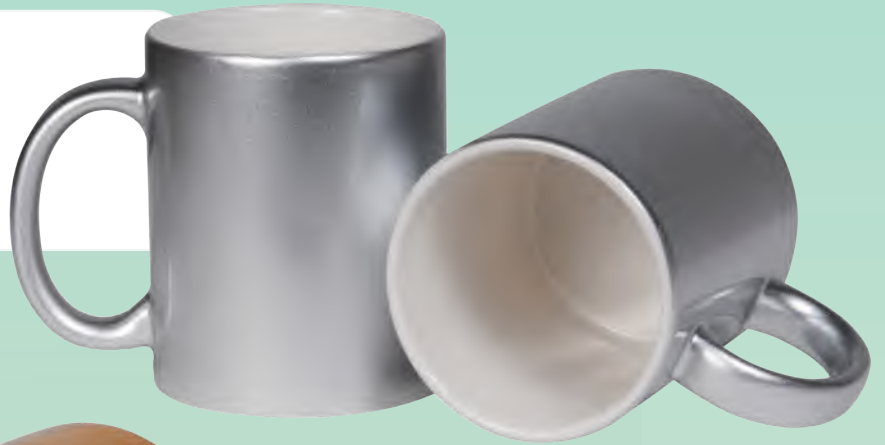
**175-G**

Glossy Finish Gold Sublimation Ceramic Mug.

325 ml 11 oz

80 x 98 mm

Sublimation

172

Glossy Finish Black Sublimation Ceramic Mug with White Printable Area.

325 ml 11 oz

80 x 98 mm

Sublimation

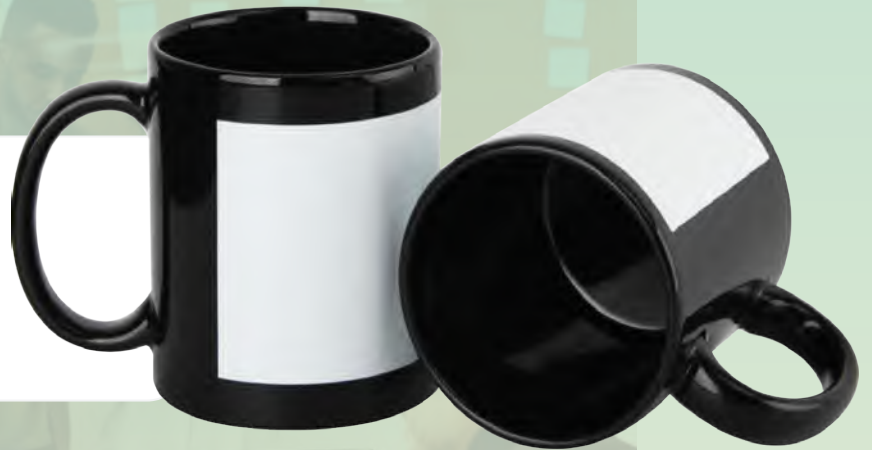

5 oz



BLK

WHT

TM-051

Ceramic tea cup with cork base. Available in Black or White options.

72 x 72 x 70 mm

Screen Printing

**TM-050-BK**

Stainless Steel Arabic Coffee Cup. Lightweight and easy to carry. Packing in 2 cups set.

65 x 45 mm

Laser Markings



180 ml

6 oz

154

Ceramic Teacups. The handle and cup's design are both incredibly chic and sophisticated.

 50 x 80 mm

 Sublimation



100 ml

3.4 oz

MU-CE187-WHT

White Ceramic Cup & Saucer. perfect choice for a promotional gift that combines style, usefulness, and brand visibility.

 Cup : 85 x 50 x 60 mm
Saucer : 105 x 15 mm

 Sublimation



77 ml

2.6 oz

MU-CE188-WHT

Ceramic Cup & Saucer. Premium white ceramic, giving them a refined and tidy appearance.

 Cup : 80 x 45 x 55 mm
Saucer : 110 x 17 mm

 Sublimation



120 ml

4 oz

180

Ceramic Tea Cup with Saucer & spoon. they are strong, resilient, and hard, ideal for brewing coffee and tea.

 50 x 80 mm

 Sublimation

LARGE SELECTION OF

Promotional Tea Coasters



COA-03

Bamboo Tea Coasters with Case. Set of 4 coasters made of natural bamboo. Presented in a bamboo holder.

110 x 110 x 35 mm

Screen Printing, UV Printing,
Laser Engraving



COA-01

Black Slate Coaster. Made from natural stone material. This coaster make an impressive gift.

100 x 100 mm

Screen Printing,
Laser Engraving



COA-02

Cork Tea Coasters. Made of authentic cork material. They are hence both lightweight and strong. They are thus ideal promotional items for your cafes, offices, and restaurants.

100 mm (dia.)
5 mm thickness

Screen Printing



KFS-WS

Cutlery Set. A compact and convenient alternative to single-use plastic cutlery. Make a natural choice with our Wheat Straw Cutlery Set consisting of a knife, spoon and fork packed in a convenient wheat straw box.

200 x 20 x 55 mm

Screen Printing, UV Printing



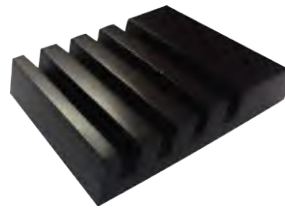

Tea Coaster
Wooden Base
optional

224

Square shaped with rounded corners. Made from Hardboard material. Lightweight and portable. Perfect for full color edge-to-edge design.

 100 x 100 mm

 Sublimation



219-F

Square Glass Tea Coaster. They were made using genuine glass materials. They are hence both lightweight and strong.

 100 x 100 mm

 Sublimation



220-F

Round Glass Tea Coaster. They were made using genuine glass materials. They are hence both lightweight and strong.

 100 x 100 mm

 Sublimation



LUN-GLB

Lunchbox in glass with bamboo lid and silicone band. Plastic-Free, BPA-Free, Reusable. High-Quality

 200 x 150 x 65 mm

 Screen Printing, UV Printing, Laser Engraving

One of the main advantages of using promotional lunchboxes in marketing campaigns is the increased brand visibility they provide.

By customizing these items with a company's logo or message, businesses can ensure that their brand is seen by potential customers every time the lunchbox is used.



LUN-WSB

Eco-friendly lunchbox made of 50% PP and 50% wheat straw. With a matching bamboo lid and elastic closure strap.

 185 x 105 x 105 mm  Screen Printing, UV Printing, Laser Engraving



LUN-WS

Lunch box made from a combination of wheat straw & PP material. BPA free material, includes an stretchable band for securing the lid and has a fork and a knife.

 85 x 130 mm  Screen Printing, UV Printing

GENERAL GIFTS

Promotional gifts have long been used as an effective marketing tool by businesses to enhance their brand visibility and attract potential customers.

Keychains
Stuff Toys & Pillow
Puzzles
Anti-stress Balls
Tiles & Ornaments

Card Holders
Wallets
Travel Essentials
Button Badges
Sign Holders

Sanitizer Bottles
Watches & Clocks
Tshirt & Polo Shirt
Caps
Wearables





KH-12-CO

Cork PU Keychains. Packed in the polybag.



38 x 93 x 2 mm



Screen Printing



KH-13-BM

Bamboo and Metal Keychain. Packed in the polybag.



32 x 85 x 3.5 mm



Screen Printing,
Laser Engraving



KH-11-BM

House shaped Bamboo and Metal Keychain. Packed in the polybag.



40 x 70 x 2 mm



Screen Printing,
Laser Engraving



KH-10-BM

Rectangular Bamboo and Metal Keychain. Packed in the polybag.



23 x 83 x 6 mm



Screen Printing, UV Printing,
Laser Engraving & Markings



KH-8-BM

Rectangular Black Metal Base Keychain with Bamboo. Packed in the polybag.



32 x 76 x 4 mm



Screen Printing,
Laser Engraving



KH-9-BM

Round shaped Bamboo and Metal Keychain. Packed in the polybag.



38 x 75 x 4 mm



Screen Printing, UV Printing,
Laser Engraving & Markings



KH-6

Round Wooden Keychain with Metal Ring 2 side printing area. Packed in the brown cardboard box.



23 x 83 x 6 mm



Screen Printing,
Laser Engraving



KH-7-BM

Round Black Metal Base Keychain with Bamboo. Packed in the polybag.



40 x 75 x 4 mm



Screen Printing,
Laser Engraving



KH-3-BK

Black Long Metal Keychain.
2 side printing area.

 55 x 15 mm

 Laser Markings



KH-3

Silver Long Metal Keychain.
2 side printing area.

 55 x 15 mm

 Laser Markings



22-BK

Black Round Shaped Metal
Keychain. 1 side printing area.

 45 x 40 mm

 Laser Markings



22

Silver Round Shaped Metal
Keychain. 2 side printing area.

 45 x 40 mm

 Digital Printing with Epoxy,
Laser Markings



23-BK

Black Rectangular Metal
Keychain. 1 side printing area.

 50 x 32 mm

 Laser Markings



23

Silver Rectangular Metal
Keychain. 2 side printing area.

 50 x 32 mm

 Digital Printing with Epoxy,
Laser Markings



25-BK

Black Rectangular Oval Metal
Keychain. 1 side printing area.

 55 x 25 mm

 Laser Markings



25

Silver Rectangular Oval Metal
Keychain. 2 side printing area.

 55 x 25 mm

 Digital Printing with Epoxy,
Laser Markings



KH-2

Metal with Strap Keychain. 2 side printing area.
Packed in the grey cardboard box.

55 x 20 mm

Laser Markings



20

Oval Shaped Metal Keychain.
1 side printing area.

50 x 28 mm

Digital Printing with Epoxy,
Laser Markings

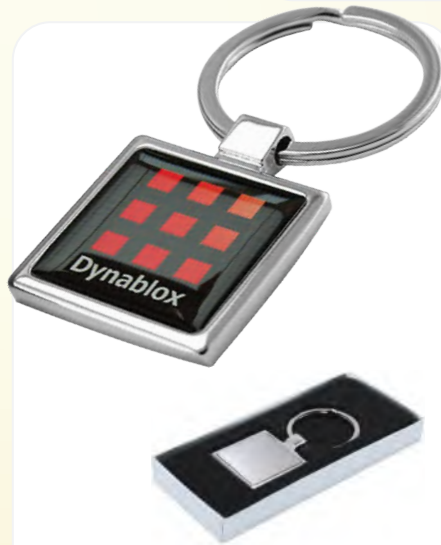

24

Square Shaped Metal Keychain.
1 side printing area.

30 x 38 mm

Digital Printing with Epoxy,
Laser Markings



26

Oval Shaped Metal Keychain.
1 side printing area.

55 x 27 mm

Digital Printing with Epoxy,
Laser Markings



27

Round Shaped Metal Keychain.
2 side printing area.

40 x 30 mm

Digital Printing with Epoxy,
Laser Markings



28

Oval Shaped Metal Keychain.
2 side printing area.

44 x 24 mm

Digital Printing with Epoxy,
Laser Markings



29

Rectangular Shaped Metal
Keychain. 2 side printing area.

53 x 28 mm

Digital Printing with Epoxy,
Laser Markings



35

Metal Keychain with Colored Strap. Debossed area for your logo. Packed in a grey cardboard box.

 60 x 28 mm

 Digital Printing with Epoxy,
Laser Markings



Metal Keychain with Colored Strap.

 60 x 28 mm

 Screen Printing,
Laser Markings



KH-4

Rectangular Plate Keychain. Packed in a grey cardboard box.

 29 x 40 x 4 mm

 Laser Markings



KH-1

Rectangular Metal Keychain with Leather Strap. Packed in a grey cardboard box.

 90 x 20 mm

 Laser Markings

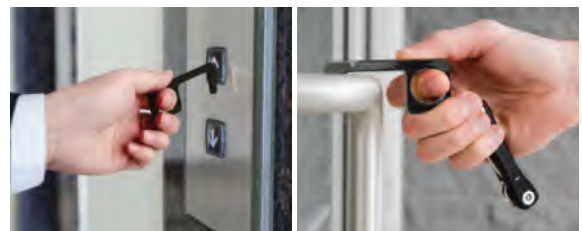

HYG-23

Touch-Free Keychain. Avoid direct contact with high-touch surfaces like public doors, store checkouts and shared buttons.

 67 x 30 x 5 mm

 Laser Markings

Why Use Promotional Candles in Marketing Campaigns?

- Candles are a unique & memorable way to promote your brand.
- Candles are a practical item that everyone can use.
- Compared to other forms of advertising, promotional candles offer a cost-effective way to reach a wide audience.
- Can be customized to fit your brand's unique style and message.



CAND-01
Vanilla Scent



CAND-02
Arabian Oud Scent

Scented Candle in a Glass Bottle with Bamboo Lid. Crafted to elevate your ambiance, infuse your surroundings with a captivating aroma. Available in 2 flavors.

 70 x 90 mm

 Screen Printing, UV Printing, Laser Engraving, UV DTF



LTR-W

Promotional Lighter. Portable device used to create a flame, and to ignite a variety of materials, such as cigars, candles or more.

 24 x 80 mm

 UV Printing



SL



BK



BL

AF-001

Promotional Flash Light. Aluminum Light weight, Small & Portable Design. Battery : AAA (not included)

 82 x 24 mm

 Laser Markings

Ceramic Tiles for Sublimation

Ceramic Tiles
Sublimation coated

 **7 different sizes**

 **Sublimation**



174
200 x 300
mm

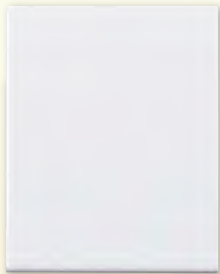

166
200 x 250
mm



164
150 x 200
mm

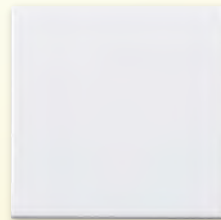

161
200 x 200
mm



162
150 x 150
mm

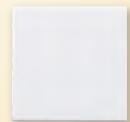

163
108 x 108
mm



165
50x50
mm



242
Heart Shaped Ornament
Decorative Ceramics

 **150 mm**

 **Sublimation**



244
Heart Shaped Ornament
Decorative Ceramics

 **100 mm**

 **Sublimation**



247
Snowflakes Shaped Ornament
Decorative Ceramics

 **75 x 75 mm**

 **Sublimation**



250
Bell Shaped Ornament
Decorative Ceramics

 **60 x 80 mm**

 **Sublimation**

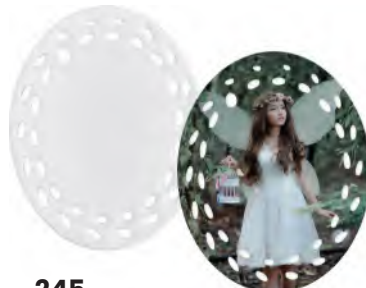

245
Oval Doily Shaped Ornament
Decorative Ceramics

 **70 x 90 mm**

 **Sublimation**



248
Round Doily Shaped Ornament
Decorative Ceramics

 **80 mm**

 **Sublimation**

Packed with powerful strategies and eye-catching materials, our toolkit is designed to elevate your marketing game to new heights.

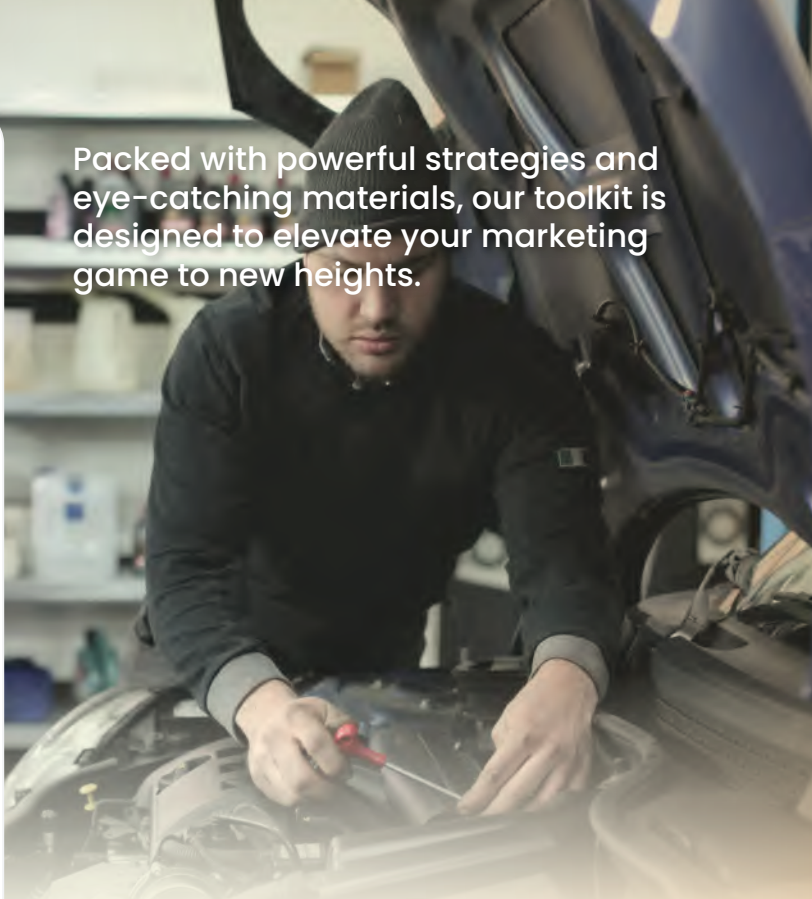

TOOL-01

Tool Kit Set in Bamboo case, includes a 10 pcs set of screw drivers with a magnetic ratchet, socket tool, bit holder and 3pcs allen key.



220 x 28 x 110 mm



Screen Printing, UV Printing
Laser Engraving, DTF Printing



TOOL-02

Tool Kit Set in Bamboo case, includes a 5 pcs set of screw drivers reattachable heads, socket wrench, and a meter.



140 x 30 x 105 mm



Screen Printing, UV Printing
Laser Engraving, DTF Printing

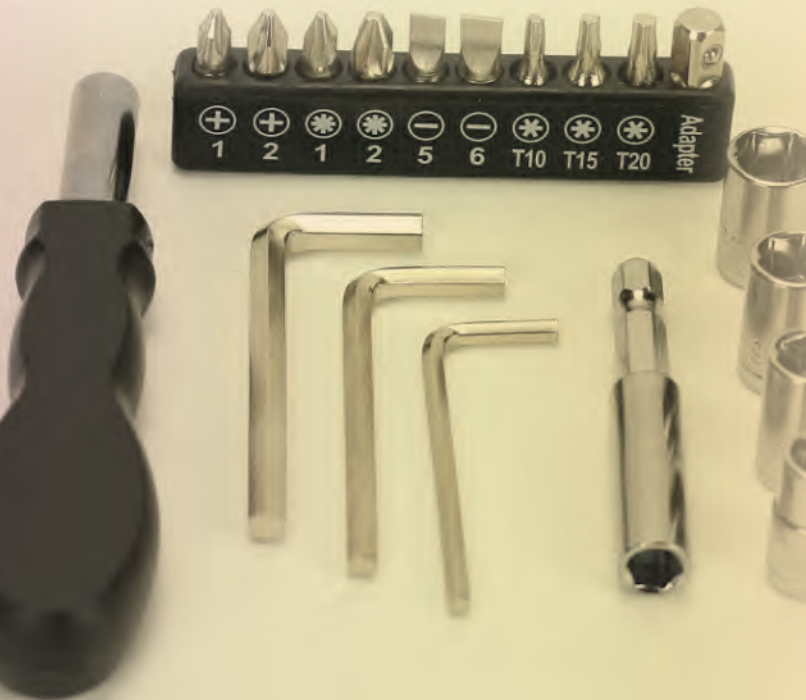



LO-01-RE

Bamboo Letter Opener. Made from white ABS plastic and bamboo trims. Ideal for letter covers and boxes.

 80 x 50 x 5 mm

 Screen Printing, UV Printing, Laser Engraving, DTF



GFK-12

Classic wooden Yoyo. Fun and entertaining game that stood the test of time. A popular fun spinning toy that you can decorate! 100cm Long String

 50 x 50 x 26 mm

 Screen Printing, UV Printing, Laser Engraving



TSB-BLK

Black Leather Tissue Box. A versatile and stylish accessory that can elevate the look of any room.

 260 x 145 x 125 mm

 Screen Printing, UV Printing

LARGE SELECTION OF

Promotional Puzzles



PP-01

Slide Puzzle. ABS Plastic material. These puzzles make wonderful presents for kids.

 75 x 90 mm

 UV Printing



PP-02

60 pcs - Rectangular Sublimation Puzzles.
Made from hardboard material.

 247 x 172 mm

 Sublimation



PP-03

30 pcs - Rectangular Sublimation Puzzles.
Made from hardboard material.

 246 x 170 mm

 Sublimation



PP-04

75 pcs - Heart Shaped Sublimation Puzzles.
Made from hardboard material.

 190 x 190 mm

 Sublimation



PP-05

80 pcs - Rectangular Sublimation Puzzles.
Made from cardboard material.

 200 x 145 mm

 Sublimation



PP-06

126 pcs - Rectangular Sublimation Puzzles.
Made from cardboard material.

 270 x 180 mm

 Sublimation



PP-09

36 pcs - Rectangular Sublimation Puzzles.
Made from hardboard material.

 270 x 180 mm

 Sublimation



PP-10

252 pcs - Rectangular Sublimation Puzzles.
Made from cardboard material.

 342 x 254 mm

 Sublimation

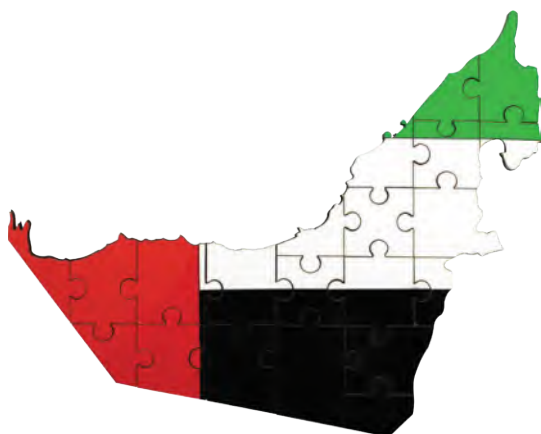

PP-08

21 pcs - UAE Shaped Sublimation Puzzles.
Made from hardboard material.

 250 x 210 mm

 Sublimation

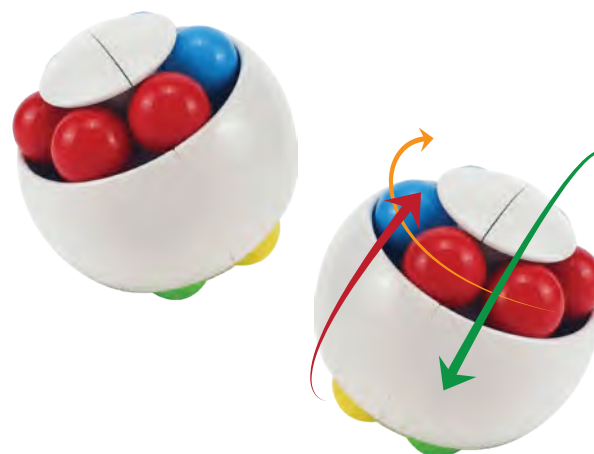

GFK-11

Spin Puzzle Balls, made from ABS plastic material. Fun and appealing alternative that you can employ for marketing.

 58 mm (dia)

 UV Printing, Pad Printing

Travel Essentials

Traveling is an activity that many individuals engage in to explore new places, experience different cultures, and create lasting memories. Carrying your brand makes it more essential.



LUG-02

Plastic Luggage Tag with rubber attachment. These are very durable and tear-resistant. These tags had a unique luggage design with a naming area and a printable size.

55 x 75 mm

Screen Printing, UV Printing



NP-01-GY

Inflatable Neck Pillow. Inflatable neck rest that supports your head. The air-filled cushion is covered in washable, soft suede-like material, and deflates for easy packing.

175 x 120 mm

Screen Printing



TLS-01

Travel set in black pouch. Includes neck pillow, sleeping mask, earplugs and socks. Supplied with 190T pouch.

15 x 200 mm

Screen Printing



018

Digital Luggage Scale. Easy to use & lightweight, Perfect size to take with you on your travels to check your luggage weight before the return journey as well. Measures up to 40 kg.

 30 x 100 x 25 mm  Screen Printing, UV Printing

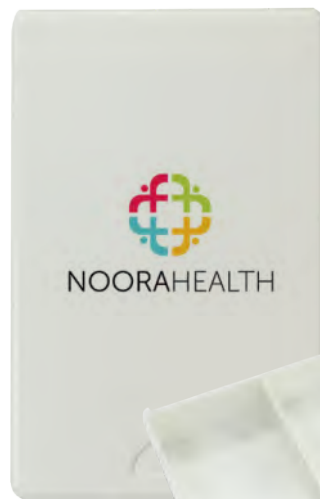

PILL-B1

Promotional Pill Box. A multi-compartment white plastic box with a easy slide open, compliance aid for storing doses of medications.

 55 x 90 mm  Screen Printing, UV Printing

Did you know?

Travel Makes You Happier than Money or Gifts

It might sound cliché, but the money you spend on travel is actually more rewarding than any material good you could buy.



DB-02

Travel Document Pouch. Horizontal Pouch for your passport & other documents. It has one pocket with a sticky closure.

 275 x 130 mm  Heat Transfer printing, Screen Printing



DB-03

Leather Passport Cover. Dorniel Designs Pouch for your passport protection.

 100 x 140 mm  Screen Printing, Express Print



HYG-32

Sanitizer Bottle. Small & Portable.
Capacity : 60 ml.

 33 x 96 mm

 Digital Printing Sticker



HYG-13-60

Hand Sanitizer Gel.
Capacity : 60 ml.
Sanitizer gel, 70% Ethyl Alcohol

 40 x 100 x 25 mm

 Digital Printing Sticker



HYG-24

Pocket Sanitizer Spray. Frosted Finish bottle with push button sprayer. Capacity : 10 ml.

 22 x 138 x 15 mm

 Digital Printing Sticker,
Screen Printing, UV Printing



HYG-09

Hand Sanitizer Gel.
Capacity : 60 ml.

 45 x 93 x 25 mm

 Digital Printing Sticker,
Screen Printing, UV Printing



HYG-09-C

Hand Sanitizer Gel with Carabiner.
Capacity : 60 ml.

 45 x 115 x 32 mm

 Digital Printing Sticker,
Screen Printing, UV Printing



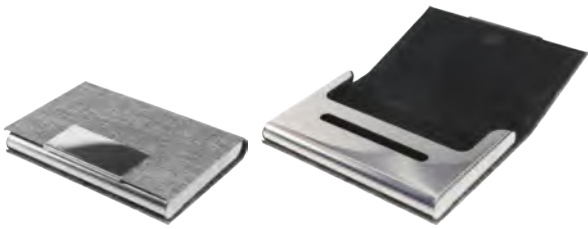
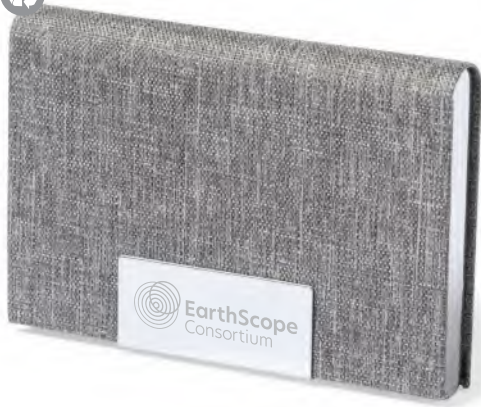

BCH-04-GRY

RPET & Chrome Metal Business Card Holders. A stylish and environmentally choice for gifts is business card holders made of RPET and chrome metal that can store 20 cards.

95 x 65 x 13 mm

Laser Markings



BCH-01

Steel Business Card Holder. Classic stainless steel that makes it easy for you keep your contact cards clean and unbent.

94 x 60 mm

Screen Printing, Laser Markings



BCH-03

Card holder with RFID Protection, Two pocket on front & large pocket on side. Available in Cork or Leather options.

68 x 106 mm

Screen Printing, UV Printing, Debossing



BCH-02

Metal Card Holder with RFID Protection. Pull down button for easy card retrieval. Semi matte texture body in black color.

95 x 63 mm

UV Printing, Laser Engraving



Available in 9 different colors



016

Anti-stress Balls. Made of squishy foam material, the feeling of squeezing these balls provides an immediate sense of satisfaction for those seeking a way to rid their stress.

 70 mm (dia.)

 Screen Printing, UV Printing



Available in 9 different colors



017

Anti-Stress Cubes are available in a five different colours and can be completely personalized with full color UV printing for greater brand identity.

 53 x 53 mm

 Screen Printing, UV Printing



016-YS

Smiley Face Anti-Stress Ball. Yellow foam ball sporting a cheerful expression. The smiley face contributes to the mood's improvement.

 70 mm (dia.)

 Screen Printing, UV Printing



016-H

Heart shaped Anti-Stress Squishy. Give a heart to show your clients you care. Has a shiny coating for a glossy appearance.

 65 x 70 x 50 mm

 Screen Printing, UV Printing



016-WN

Anti Stress - Round Flat Surface. Round shape with flat surface for your logo. It comes in a bright white color and is composed of high-quality rubber.

 70 x 25 mm

 Screen Printing, UV Printing



707

Cushions. Made from polyester and cotton material.

 355 x 405 mm

 Sublimation

Available in 6 different colors

BG **BL** **PK** **PR** **R** **Y**





TB-02-A
20cm height

TB-02-B
25cm height

TB-02

Teddy Bear Toys with Printable White Tshirt. Offer it to your loved ones as a present on important occasions to make them feel more special and cared for.

220 x 200 x 160 mm
300 x 280 x 250 mm Heat Transfer Printing



TB-03-BRW-25
25cm height

TB-03-BRW-35
35cm height

TB-03

Promotional Camel Toy. Plush toys for promotions available in a brown color with a white blanket. Available in 2 different sizes.

210 x 250 x 132 mm
310 x 350 x 210 mm Heat Transfer Printing



TB-04

Falcon Plush Toys with White Scarf. Crafted from premium 100% polyester material, our Falcon plush is ultra-soft and gentle to the touch, making it ideal for cuddling.

190 x 220 x 140 mm Heat Transfer Printing

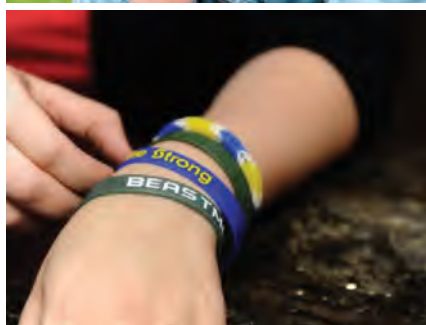

014

Silicone Wristband. They're an economical choice yet extremely durable, lightweight, washable and comfortable for everyday wear.

100 x 12 mm

Screen Printing

Available in 12 different colors



READY-MADE

014-BC

Breast cancer Silicone Wristband. Durable, lightweight, washable and comfortable for your event and everyday wear.

100 x 12 mm



TWB

Tyvek wristbands provide an economical and secure way to identify customers across countless types of events.

175 x 120 mm

Screen Printing



Available in 13 different colors



WRISTWATCHES AND CLOCKS

Explore the world of wristwatches and clocks today and discover the beauty of timekeeping at its best. Whether you are looking for a statement piece for your wardrobe or a conversation starter for your home, these iconic timepieces are sure to leave a lasting impression.





WCP-C5

Wireless Charger Clock. Made from Bamboo and Limestone Cement material. Analog Clock design display Coils : 1 pc, Input : DV 5V-2A, Wireless Output: 5W.

120 x 83 x 77 mm



Screen Printing, UV Printing



JU-WCP-CLK

Bamboo Wireless Charger with Clock, Alarm & Thermometer function. Pure bamboo texture surface, Stylish appearance. Integrated with LED digital display.

170 x 82 x 40 cm



Screen Printing, Laser Engraving



CLK-16-BM

Triangular wooden digital desk clock with display time, date & temperature. Eco-Friendly design. 12/24hr format. With easy to read LED digits display.

121 x 80 x 80 mm



Screen Printing, UV Printing Laser Engraving.



CLK-15-BM

Rectangular Bamboo Desk Clock. Analog Clocks function. Made by hand with excellent craftsmanship, silent, and without ticking.

162 x 86 x 38 mm



Screen Printing, UV Printing Laser Engraving.



CLK-17

Bamboo Wall Clock. Modern and eco-friendly vibe to any room. The warm tones of bamboo blend effortlessly with various decor styles, making it a versatile choice.

280 (dia) x 40 mm Laser Engraving
UV DTF Printing



CLK-13-BM

Bamboo Desk/Wall Clock. LCD display with easy to read digits. 12/24hr format. Alarm, Calendar, Forecast & Temperature function. Date and weekday. display.

130 x 130 x 24 mm Screen Printing, UV Printing
Laser Engraving.



CLK-14-BM

Bamboo Photo Frame with Clock. LCD display with easy to read digits. 12/24hr format. Alarm, Calendar, Forecast & Temperature function. Date and weekday display.

183 x 183 x 20 mm Screen Printing, UV Printing
Laser Engraving.



CLK-12

Digital Table Clock. Multi Display Digital Clock, Clock, Month, Date & Temperature with Alarm & Snooze Function.

23 x 14 x 2.5 mm Screen Printing, UV Printing

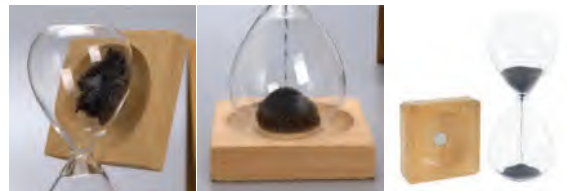

MST-01

Wooden base sand timer. Made from high borosilicate glass with wood and iron. Sand timer is 2 minutes.

65 x 150 mm Screen Printing, UV Printing



WCP-CLK-03

Desktop Wireless Charging station with clock + alarm function and LED desk lamp and pen holder.

130 x 155 x 445 mm Screen Printing, UV Printing
DTF Printing



WCP-CLK-01

Wireless Charger with Clock and LED night light. Designed with elegance, sleek and compact profile adds a stylish to your table, anti-slip pad ensures your devices align perfectly.

168 x 118 x 111 mm Screen Printing

GENERAL PROMO GIFTS

Promotional Wristwatches



In the modern world, time management is critical to individual organization and productivity.



WA-01

Raphael Promotion Wristwatches.

 Gents : 43 mm
Ladies : 32 mm



-  Full Color Logo on Dial
-  Metal Marking on Back



WA-03

Raphael Promotion Wristwatches.

 Gents : 43 mm
Ladies : 32 mm



-  Full Color Logo on Dial
-  Metal Marking on Back



WA-04S

Raphael Promotion Wristwatches.

 Gents : 43 mm
Ladies : 32 mm



-  Full Color Logo on Dial
-  Metal Marking on Back



WA-04G

Raphael Promotion Wristwatches.

 Gents : 43 mm
Ladies : 32 mm

-  Full Color Logo on Dial
-  Metal Marking on Back





WA-02

Raphael Promotional Wristwatches.

 Gents : 43 mm
Ladies : 32 mm

-  • Full Color Logo on Dial
- Metal Marking on Back



WA-05

Raphael Promotional Wristwatches.

 Gents : 43 mm
Ladies : 32 mm

-  • Full Color Logo on Dial
- Metal Marking on Back



WA-06

Raphael Promotional Wristwatches.

 Unisex : 40 mm

-  • Full Color Logo on Dial
- Metal Marking on Back



WA-10

Raphael Promotional Wristwatches.

 Unisex : 46 mm

-  • Full Color Logo on Dial
- Metal Marking on Back



WA-07LS

Raphael Promotional Wristwatches.

 Gents : 35 mm
Ladies : 30 mm

-  • Full Color Logo on Dial
- Metal Marking on Back



WA-07LG

Raphael Promotional Wristwatches.

 Gents : 35 mm
Ladies : 30 mm

-  • Full Color Logo on Dial
- Metal Marking on Back





WA-25

Raphael Promotional Wristwatches.



Gents : 43 mm
Ladies : 30 mm



- Full Color Logo on Dial
- Metal Marking on Back



WA-08G

Raphael Promotional Wristwatches.



Gents : 41 mm



- Full Color Logo on Dial
- Metal Marking on Back



WA-09G

Raphael Promotional Wristwatches.



Gents : 43 mm



- Metal Marking on Back



WA-11G

Raphael Promotional Wristwatches.



Gents : 44 mm



- Full Color Logo on Dial
- Metal Marking on Back



WA-12G

Raphael Promotional Wristwatches.



Gents : 44 mm



- Full Color Logo on Dial
- Metal Marking on Back



WA-13

Raphael Promotional Wristwatches.



Gents : 46 mm



- Full Color Logo on Dial
- Metal Marking on Back

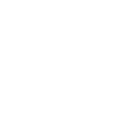





WA-14G

Raphael Promotional Wristwatches.

 Gents : 46 mm

-  Full Color Logo on Dial
-  Metal Marking on Back



WA-15G

Raphael Promotional Wristwatches.

 Gents : 43 mm

-  Metal Marking on Back



WA-16

Raphael Promotional Wristwatches.

 Gents : 46 mm

-  Metal Marking on Back



WA-17

Raphael Promotional Wristwatches.

 Gents : 46 mm

-  Metal Marking on Back



WA-18G

Raphael Promotional Wristwatches.

 Gents : 46 mm

-  Metal Marking on Back



WA-19G

Raphael Promotional Wristwatches.

 Gents : 43 mm

-  Metal Marking on Back





WA-21G

Raphael Promotional Wristwatches.

 Gents : 45 mm

 Metal Marking on Back



WA-22G

Raphael Promotional Wristwatches.

 Gents : 43 mm

 Metal Marking on Back



WA-23G

Raphael Promotional Wristwatches.

 Gents : 42 mm

 Metal Marking on Back



WA-24G

Raphael Promotional Wristwatches.

 Gents : 44 mm

 Metal Marking on Back



WA-26G

Raphael Promotional Wristwatches.

 Gents : 42 mm

 Metal Marking on Back



WA-20

Raphael Promotional Keychain Watches.

 46 mm

 • Full Color Logo on Dial
• Metal Marking on Back





WA-10G

Gents Watch : 43mm.
• Full color design



WA-12G

Gents Watch : 44mm.
• Full color design



WA-25GP

Gents Watch : 43mm.
• Full color design



WA-25LP

Ladies Watch : 30mm.
• Full color design



Customized Photo Dials

ex. Commercial, Educational,
Birthdays, Anniversaries & Wedding
or Other types of Occasions.



+



=



GENERAL PROMO GIFTS

Promotional Button Badges

Small, round badges typically feature compelling images, slogans or logos designed to attract attention & promote a message in an eye-catching way.



REUSE
REDUCE
RECYCLE



Bio material instead of metal sheet!

409

Biodegradable Button Badge with Backside Pin/Clip. Recyclable & CO2 neutral. Natural haptics and top-quality looks.

56 mm

Digital Printing



75mm Button Badge



56mm Button Badge



44mm Button Badge



32mm Button Badge



629-M : Metal Badge

629-P : Plastic Badge

Oval Shaped Button Badges. These are perfect for your oval or rectangular logos. Backside with Pin.

65 x 60 mm

Digital Printing

| | |
|-------|-----------------------------------|
| 625 | 75 mm Chinese Metal Button Badge |
| 625-P | 75 mm Plastic Button Badge |
| 405 | 56 mm Metal Button Badge |
| 403 | 44 mm American Metal Button Badge |
| 623 | 44 mm Chinese Metal Button Badge |
| 623-P | 44 mm Plastic Button Badge |
| 401 | 32 mm American Metal Button Badge |
| 622 | 32 mm Chinese Metal Button Badge |
| 622-P | 32 mm Plastic Button Badge |



406

Hexagon Button Badges. Button badges that are quite unique and look great.

65 x 60 mm

Digital Printing



56 mm
627

44 mm
626

Metal Button Badges with a magnet attachment on backside.

Available in 2 sizes

Digital Printing



630

Plastic Button Badges with Keychain attachment.

44 mm

Digital Printing



405-N

American Metal Button Badges with Bottle opener. (Optional Keyring)

56 mm

Digital Printing



157-F

Frosted Foldable Plastic Display Stand. Optional Stand for your Button Plate.

44 mm

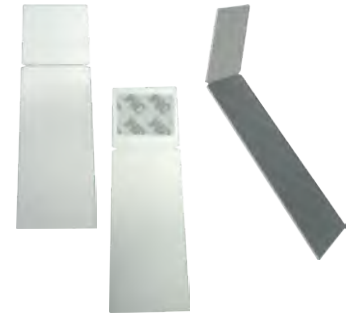

157-M

Silver Metal Easel. Optional Stand for your Button Plate.

50 x 140 mm



644

Photo Button with Coin bank for Wall or Table placement.

158 mm

Digital Printing



643

Photo Button with Built-in stander

158 mm

Digital Printing



642

Photo Button with Analog Clock.

158 mm

Digital Printing



NEXTT LEVEL

GO SUSTAINABLE

ULTRA-SOFT BREATHABLE FABRIC
MADE FROM RECYCLED PET BOTTLES

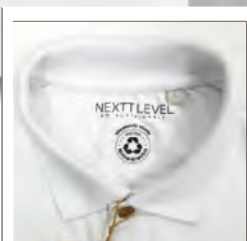

NECK LABEL BRANDING



BRANDED BUTTONS



BRANDED HANG TAGS

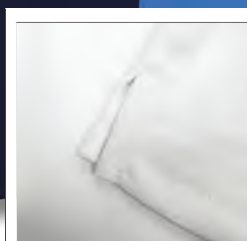

SIDE SLITS

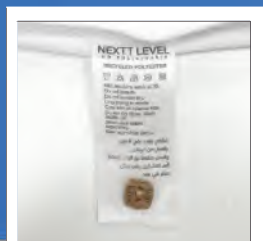

CARE LABEL WITH EXTRA BUTTON

Introducing Nextt Level Polo Shirts, where sustainability meets supreme comfort. These remarkable polo shirts are crafted using 100% recycled PET bottle polyester, making them a truly eco-friendly choice for the fashion forward individual.

One of the first things you'll notice about these polo shirts is the luxurious softness of the fabric against your skin. The ultra-soft feel enhances the wearing experience, ensuring a pleasant sensation with every touch.

Available in: **XS** **S** **M** **L** **XL** **2XL** **3XL**





Basic T-Shirt & Polo Shirt for Single or Full-color printing.



Basic Colored Promotional T-shirt.
 Good quality material with a Soft Texture.
 Printable with Single color or Full colored design.



Available in different sizes



Screen Printing, Heat Transfer



Basic Colored Promotional Polo-shirt.
 Good quality material with a Soft Texture.
 Printable with Single color or Full colored design.



Available in different sizes



Screen Printing, Heat Transfer

COOL TEX®

COOL & DRY - DRI-FIT



Polo-Shirts (Unique Blend)

The Key Feature of the fabric is that it is constructed in a way where the inside of the fabric worn next to the skin is predominantly cotton and the outside is polyester. this therefore combines the comfort of cotton with the hardwearing properties of polyester.

- » Easy Care
- » Breathability
- » Shape Retention
- » Total Comfort
- » Wickability
- » Softness
- » Quick Drying
- » UV Protection



Premium Quality
2-Buttons Box Placket



COOLTEX
Branded Buttons



Side slits
on bottom



CAP-M

Promotional Caps - Soft Mesh Material. 5 Panel Soft Mesh Sandwich Cap with Flexible Fit Elastic Band.



270 x 195 mm



Screen Printing, Heat Transfer
Embroidery



SG

Promotional Glasses tinted to protect the eyes from sunlight or glare. Available in white or black glasses.



One general size



Screen Printing, UV Printing



183

Sublimation Tie. White tie is made of polyester, a soft and comfortable material. Fashionable & looks good



One general size



Sublimation



AP-C

Cotton Apron with Pocket. A protective garment worn over the front of one's clothes. Promote your brands in a cafe, restaurant or even on personal use. 100% cotton material.

 60 x 92 mm

 Screen Printing, Sublimation



SV-01

Reflective Safety Vest. Approved to CE safety regulations. With double reflective strip around the body and velcro closures. ISO Certified, European Standard, 120 GSM Polyester.

M **XL** **L** **XXL**

 Screen Printing
Sublimation



Desk Flag with Base

Flag with pole that can be use in any office, school, or any function, made of high quality satin which is strong and looks beautiful vibrant original flag colors.



FLS-GL

Flag Stand with Metal Pole & Glass Base.

Pole/Base - 78 x 288mm, Flag - 300 x 200mm



FLS-MTL

Flag Stand with Metal Pole & Silver Base.

Pole/Base - 70 x 365mm, Flag - 300 x 200mm



CHAMIN SERIES

Acrylic Table Display Stand. Crafted from high-quality PMMA material. Elevate your identification presentation with the sleek and practical design of the "Chamin" series.

 Available in 4 sizes  Digital Printing

| | |
|----------|---------------------|
| DIS-5241 | 54 x 85 mm |
| DIS-5243 | 102 x 152 mm |
| DIS-5246 | 152 x 203 mm |
| DIS-5247 | 210 x 297 mm (A4) |



GERRYDELOS SERIES

Table Display Stand. A perfect fusion of PMMA and Copper materials, providing both durability and sophistication.

 Available in 3 sizes  Digital Printing

| | |
|----------|---------------------|
| DIS-5373 | 105 x 148 mm |
| DIS-5372 | 148 x 210 mm (A5) |
| DIS-5371 | 210 x 297 mm (A4) |



VILANI SERIES

Acrylic Table Display Stand. Crafted from high-quality PMMA material, offering both functionality and style. Ensures a clear message while maintaining a sleek and professional look.

 Available in 4 sizes  Digital Printing

| | |
|----------|---------------------|
| DIS-5012 | 100 x 200 mm |
| DIS-5015 | 105 x 148 mm |
| DIS-5016 | 148 x 210 mm (A5) |
| DIS-5017 | 210 x 297 mm (A4) |



PLATINUM SERIES

Metal Table Display Stand. A sleek and durable solution for protecting & presenting your name and designation. Combining functionality & elegance in one design.

Available in 2 sizes Digital Printing

DIS-5233-1 80 x 150 mm

DIS-5233-2 210 x 100 mm

EASICO SERIES

Acrylic Table Display Stand. Showcases a modern design with a combination of PS, offering a sturdy & stylish solution to protect your presented label.

210 x 41 x 62 mm Digital Printing

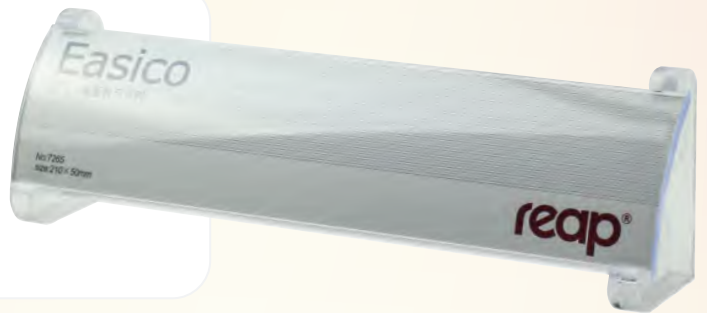

MIRA SERIES

Acrylic Table Display Stand. It's commonly used in retail, exhibitions, and even personal collections to present products, menus, or information.

250 x 80 x 85 mm Digital Printing



DIS-5802-1

Metal Table Display Stand. A sleek and durable solution for protecting & presenting your name and designation. Combining functionality & elegance in one design.

210 x 41 x 62 mm Digital Printing



FENDIGE SERIES

Acrylic Table Display Stand, a perfect fusion of PMMA and AL materials, providing both durability and sophistication.



Available in 3 sizes



Digital Printing

DIS-5362

120 x 210 mm

DIS-5363

148 x 210 mm (A5)

DIS-5364

210 x 297 mm (A4)



Transparent Acrylic Desk Sign Holder with the stand. Ideal for displaying specials, beverages, and even advertising promotions.



Available in 2 sizes



Digital Printing

DSH-02

80 x 50 mm

DSH-03

65 x 45 mm



DSH-11

Silver Desk Sign Holder. Metal slide plate for your desk can be printed with full color printing. Made from a strong aluminum. Simple and modern style.



255 x 55 mm



Sublimation



DSH-12

Bronze Desk Sign Holder. Metal slide plate for your desk can be printed with full color printing. Made from a strong aluminum. Simple and modern style.



255 x 55 mm



Sublimation



DSH-13

Black Desk Sign Holder. Metal slide plate for your desk can be printed with full color printing. Made from a strong aluminum. Simple and modern style.



255 x 55 mm



Screen Printing



SONIC SERIES

Aluminium Wall Mount Holder. The holders feature a magnetic backing, ensuring easy attachment to magnetic surfaces for convenient display.

Available in 6 sizes Digital Printing

| | |
|----------|-------------------|
| DIS-3113 | 297 x 420 mm (A3) |
| DIS-3115 | 210 x 297 mm (A4) |
| DIS-3116 | 148 x 210 mm (A5) |
| DIS-3117 | 105 x 148 mm (A6) |
| DIS-3118 | 52 x 148 mm |
| DIS-3119 | 120 x 297 mm |



Magnetic Display Board. A versatile display board that can be used for a variety of purposes. Magnetic backing allows for easy attachment of materials. Lightweight and portable.

Available in 2 sizes Digital Printing

| | |
|----------|-------------------|
| DIS-3126 | 297 x 420 mm (A3) |
| DIS-3127 | 210 x 297 mm (A4) |



Magnetic Display Board. The front opening design is more convenient and quick to replace the inner page. Comes with self-adhesive, easy installation.



Available in 2 sizes Digital Printing

| | |
|----------|-------------------|
| DIS-3191 | 297 x 420 mm (A3) |
| DIS-3190 | 210 x 297 mm (A4) |



DIS-3185

A4 Magnetic Display Board. a popular choice, offering a self-adhesive magnetic frame that can be used for displaying photos, notices, certificates, and posters.



 210 x 297 mm (A4)  Digital Printing

WSH-03
255 x 105 mm



WSH-01
255 x 55 mm

Silver Wall Sign Holder. Metal slide plate for your office, buildings, etc. that is affixed to a wall or other smooth surface for intentional message and informational purposes.

 Available in 2 sizes  Sublimation

WSH-04
255 x 105 mm



WSH-02
255 x 55 mm

Bronze Wall Sign Holder. Metal slide plate for your office, buildings, etc. that is affixed to a wall or other smooth surface for intentional message and informational purposes.

 Available in 2 sizes  Sublimation



WSH-06-BK
Wall Sign Holder. Made from Aluminum material.

 210 x 105 mm  Digital Printing



WSH-05-SL
Corridor Signage Holders. Made from Aluminum material.

 64 x 102 x 23 mm  Digital Printing



Exhibition Floor Sign Stands. Essential display tools for trade shows, conferences, and promotional events. Designed to hold and showcase signs and informations.

Exhibition Floor Sign Stands. a perfect blend of aluminum alloy and acrylic materials, combining durability with a modern aesthetic.

 Available in 2 sizes  Digital Printing

 Available in 2 sizes  Digital Printing

| | |
|----------|---------------------|
| DIS-3026 | 297 x 420 mm (A3) |
| DIS-3025 | 210 x 297 mm (A4) |

| | |
|----------|---------------------|
| DIS-3012 | 297 x 420 mm (A3) |
| DIS-3008 | 210 x 297 mm (A4) |

PINS AND BADGES

PROMOTIONAL PINS AND BADGES

A must-have accessories for individuals of all ages. Whether you're looking to express your unique style, show support for a cause, or simply add a pop of personality to your outfit, pins and badges are the perfect way to make a statement





Gold Round Rope Design Metal Badges

Backside Options : Pin, Butterfly Clutch or Magnet.



Available in 5 sizes



Digital Printing with Epoxy

| | |
|--------|-------------------|
| 2044-G | 13 mm Metal Badge |
| 2045-G | 22 mm Metal Badge |
| 2046-G | 27 mm Metal Badge |
| 2047-G | 37 mm Metal Badge |
| 2048-G | 47 mm Metal Badge |



Silver Round Rope Design Metal Badges

Backside Options : Pin, Butterfly Clutch or Magnet.



Available in 5 sizes



Digital Printing with Epoxy

| | |
|--------|-------------------|
| 2044-S | 13 mm Metal Badge |
| 2045-S | 22 mm Metal Badge |
| 2046-S | 27 mm Metal Badge |
| 2047-S | 37 mm Metal Badge |
| 2048-S | 47 mm Metal Badge |



Bronze Round Rope Design Metal Badges

Backside Options : Pin, Butterfly Clutch or Magnet.



Available in 3 sizes



Digital Printing with Epoxy

| | |
|--------|-------------------|
| 2044-B | 13 mm Metal Badge |
| 2046-B | 27 mm Metal Badge |
| 2047-B | 37 mm Metal Badge |



Gold Oval Rope Design Metal Badges

Backside Options : Pin, Butterfly Clutch or Magnet.



Available in 4 sizes



Digital Printing with Epoxy

| | |
|--------|------------------------|
| 2040-G | 22 x 15 mm Metal Badge |
| 2041-G | 28 x 20 mm Metal Badge |
| 2042-G | 37 x 26 mm Metal Badge |
| 2043-G | 47 x 31 mm Metal Badge |



Silver Oval Rope Design Metal Badges

Backside Options : Pin, Butterfly Clutch or Magnet.



Available in 4 sizes



Digital Printing with Epoxy

| | |
|--------|-------------------|
| 2044-N | 13 mm Metal Badge |
| 2045-N | 22 mm Metal Badge |
| 2046-N | 27 mm Metal Badge |
| 2047-N | 37 mm Metal Badge |



Silver Oval Rope Design Metal Badges

Backside Options : Pin, Butterfly Clutch or Magnet.



Available in 4 sizes



Digital Printing with Epoxy

| | |
|--------|-------------------|
| 2044-B | 13 mm Metal Badge |
| 2045-B | 22 mm Metal Badge |
| 2046-B | 27 mm Metal Badge |
| 2047-B | 37 mm Metal Badge |



Gold Round Flower Design Metal Badges

Backside Options : Pin, Butterfly Clutch or Magnet.

 Available in 3 sizes  Digital Printing with Epoxy

| | |
|--------|-------------------|
| 2037-G | 20 mm Metal Badge |
| 2038-G | 25 mm Metal Badge |
| 2039-G | 35 mm Metal Badge |



Silver Round Flower Design Metal Badges

Backside Options : Pin, Butterfly Clutch or Magnet.

 Available in 3 sizes  Digital Printing with Epoxy

| | |
|--------|-------------------|
| 2037-N | 20 mm Metal Badge |
| 2038-N | 25 mm Metal Badge |
| 2039-N | 35 mm Metal Badge |



Bronze Round Flower Design Metal Badges

Backside Options : Pin, Butterfly Clutch or Magnet.

 Available in 3 sizes  Digital Printing with Epoxy

| | |
|--------|-------------------|
| 2037-B | 20 mm Metal Badge |
| 2038-B | 25 mm Metal Badge |
| 2039-B | 35 mm Metal Badge |



2029

Flat Oval Metal Badges.

Backside Options : Pin, Butterfly Clutch or Magnet.

45 x 20 mm

Digital Printing with Epoxy

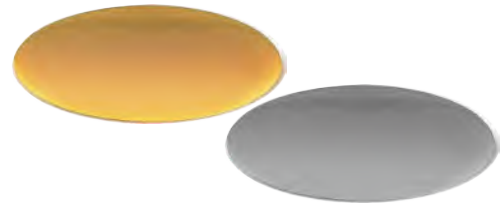

2028

Flat Oval Metal Badges.

Backside Options : Pin, Butterfly Clutch or Magnet.

35 x 15 mm

Digital Printing with Epoxy

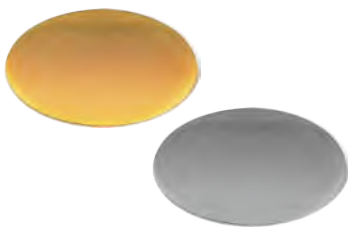

2027

Flat Oval Metal Badges.

Backside Options : Pin, Butterfly Clutch or Magnet.

25 x 15 mm

Digital Printing with Epoxy

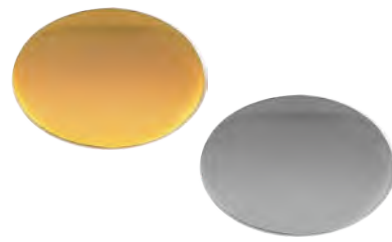

2033

Flat Oval Metal Badges.

Backside Options : Pin, Butterfly Clutch or Magnet.

25 x 18 mm

Digital Printing with Epoxy



Flat Round Rope Design Metal Badges

Backside Options : Pin, Butterfly Clutch or Magnet.

Available in 5 sizes

Digital Printing with Epoxy

| | |
|---------|---------------------------|
| 2034-N | 15 mm Metal Badge |
| 2024-N | 20 mm Metal Badge |
| 2025-N | 25 mm Metal Badge |
| 2083-SS | 30 mm Metal Badge - Shiny |
| 2026-SS | 35 mm Metal Badge - Shiny |



Flat Round Rope Design Metal Badges

Backside Options : Pin, Butterfly Clutch or Magnet.

Available in 5 sizes

Digital Printing with Epoxy

| | |
|--------|-------------------|
| 2034-G | 15 mm Metal Badge |
| 2024-G | 20 mm Metal Badge |
| 2025-G | 25 mm Metal Badge |
| 2083-G | 30 mm Metal Badge |
| 2026-G | 35 mm Metal Badge |



optional backside : Pin, Butterfly Clutch or Magnet

Flat Square Metal Badges

Backside Options : Pin, Butterfly Clutch or Magnet.

Available in 3 sizes Digital Printing with Epoxy

| | |
|----------|-------------------------------|
| 2030-22G | 22 x 22 mm Gold Metal Badge |
| 2030-22N | 22 x 22 mm Silver Metal Badge |
| 2030-18G | 18 x 18 mm Gold Metal Badge |
| 2030-18N | 18 x 18 mm Silver Metal Badge |



Magnet

Butterfly Clutch

LP-101N30

Round Shaped Black Metal Badges.

Backside Options : Magnet or Butterfly Clutch

30 mm (dia) Digital Printing with Epoxy



Magnet

Butterfly Clutch

2115

Round Shaped Gold Metal Badges.

Backside Options : Magnet or Butterfly Clutch

20 mm (dia) Digital Printing with Epoxy



Magnet

Butterfly Clutch

2106

Heart Shaped Metal Badges.

Backside Options : Magnet or Butterfly Clutch

30 x 32 mm Digital Printing with Epoxy

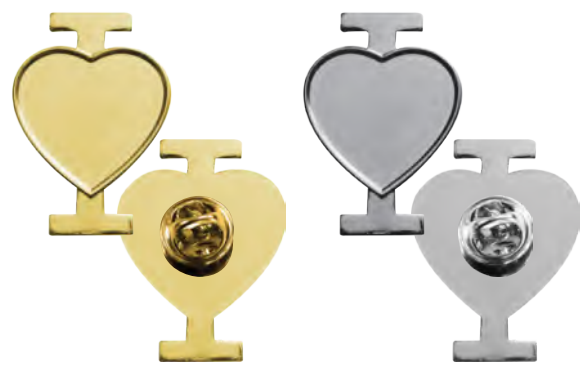

2082

I Love design Metal Badges.

Backside with Butterfly Clutch.

20 x 30 mm Digital Printing with Epoxy



2053-N

Square shaped with curved corner Metal Badges.
Backside with Butterfly Clutch.

25 x 25 mm

Digital Printing with Epoxy



2049

Arched Shaped Metal Badges.
Backside with Butterfly Clutch.

30 x 30 mm

Digital Printing with Epoxy



2094

Flag with Round Metal Badges.
Backside Options : Butterfly Clutch or Magnet.

25 x 35 mm

Digital Printing with Epoxy



2094-G-UAE

UAE Flag with Round Metal Badges.
Backside Options : Butterfly Clutch or Magnet.

25 x 35 mm

Digital Printing with Epoxy



2092 : Butterfly Clutch

2092-WM : Magnet

2092

Flag Metal Badges. Gold plated.
Backside Options : Butterfly Clutch or Magnet.

20 x 15 mm

Digital Printing with Epoxy



2091

Flag Metal Badges. Backside with Butterfly Clutch.

20 x 15 mm

Digital Printing with Epoxy



* Optional Flag Designs *

2081

Two-Flag Metal Badges. Backside with Butterfly Clutch.

35 x 25 mm

Digital Printing with Epoxy



2031

Rectangular Shaped Metal Badges. Backside with Butterfly Clutch.

30 x 17 mm

Digital Printing with Epoxy

READY-MADE BADGES



NDB-21

UAE Flag Metal Badge. Debossed design with colour filling. Backside magnet attachment.

35 x 20 mm

READY-MADE BADGES



NDB-19

UAE National Brand Metal Badge. Debossed design with colour filling. Backside magnet attachment.

39 x 29 mm

READY-MADE BADGES



2101

Dubai Metal Badge. Debossed design with colour filling. Backside magnet attachment.

50 x 21 mm

READY-MADE BADGES



2115-GR

Gold Metal Badge with enamel green round design. Backside gold magnet attachment.

19 mm (dia.)

READY-MADE BADGES



LP-FLN40-KSA

KSA Flag Metal Badge. Debossed design with colour filling. Backside magnet attachment.

40 x 20 mm

READY-MADE BADGES



LP-FWM10-KSA

KSA Flag Metal Badge. Debossed design with colour filling. Backside magnet attachment.

20 x 15 mm

READY-MADE BADGES



LP-BCP15 : Butterfly Clutch

LP-BCM20 : Magnet

Pink Ribbon Metal Badge. Debossed design with colour filling. Ideal for Breast Cancer awareness events.

(LP-BCP15) 15 x 30 mm, (LP-BCM20) 20 x 40 mm.

READY-MADE BADGES



2114

Magnet

Butterfly Clutch

Smiley Design Metal Badge. Debossed design with colour filling. Optional Backside attachment.

30 mm (dia.)

READY-MADE BADGES



NDB-16

UAE Flag Metal Badge. Debossed design with colour filling. Backside magnet attachment.

 30 x 30 mm

READY-MADE BADGES



NDB-17

UAE Map Shape Flag Badges. Debossed design with colour filling. Backside magnet attachment.

 40 x 30 mm

READY-MADE BADGES



2102

UAE Peace Sign Metal Badge. Debossed design with colour filling. Backside magnet attachment.

 28 x 35 mm

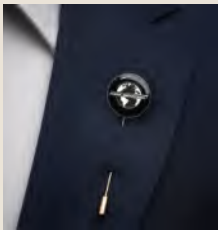

Promotional Lapel Pins

It has been a popular accessory for many years, worn by people from all walks of life.

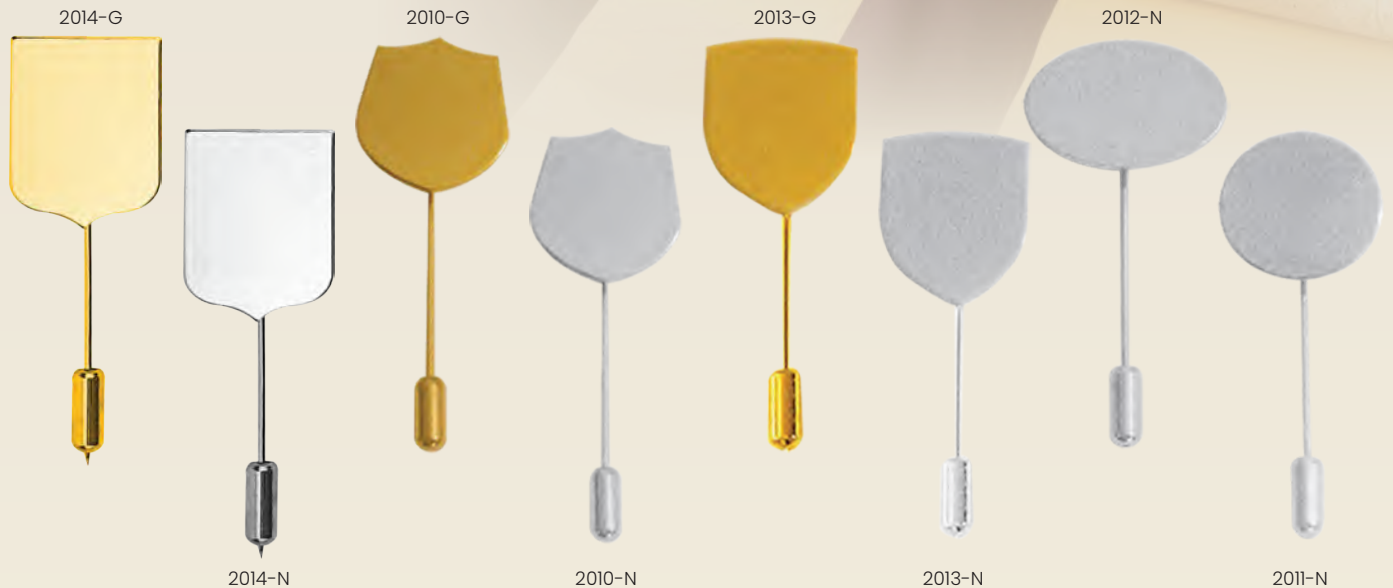

2014-G

2010-G

2013-G

2012-N

2014-N

2010-N

2013-N

2011-N

Medals

In today's society, the concept of medals holds great significance and value. Medals are physical symbols of achievement and recognition.



2065-G



2065-N



2065-B

2065

Promotional Medal. We provide premium medals at competitive costs so that everyone can experience the joy of winning! Available in Gold / Silver / Bronze

 65 mm (dia)

 Digital Printing
with Epoxy Doming



2065-G



2065-N



2065-B

2064

Promotional Medal. We provide premium medals at competitive costs so that everyone can experience the joy of winning! Available in Gold / Silver / Bronze

 50 mm (dia)

 Digital Printing
with Epoxy Doming

Optional Medal Ribbons



2065R-UAE



2065R-KSA



2065R-OM



2065R-BH



2065R-QT



2067

Fantastic alternative option to traditional medals, glass medals can be printed in full color or laser engraving. Elevate your medal award to your award winners.

 80 mm (dia)

 UV Printing, Laser Engraving



2084-N

Silver Plated Pin Medal. Backside with Pin attachment.

 55 mm (dia)

 Digital Printing with Epoxy



2055

Medal Pin Badges. Backside with Pin attachment.

 45 mm (dia)

 Digital Printing with Epoxy

Custom Made Medals



We are constantly creating new ideas that combines your design with metal medals, blend in with little masterpieces. The precisely developed design makes customers be amazed with the output of our medals. Promoting your logo in full colour.

You can also choose from our pre-made basic cut medals.

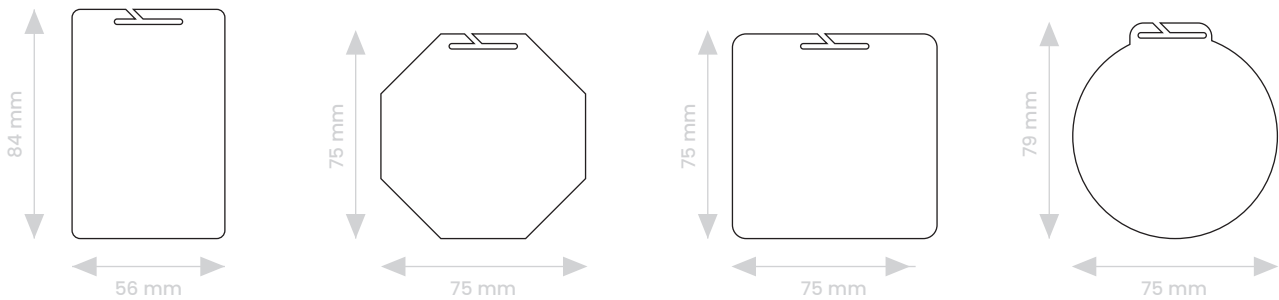

We have also offer a combination of metal & acrylic medals



ID SOLUTIONS

The need for secure and reliable identification solutions has never been more crucial. From all transactions to accessing secure buildings, having the right Identification in place is essential for both individuals and businesses.



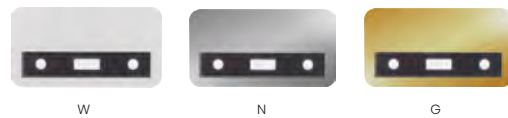

INB-05

Aluminum Reusable Insert Name Badge.
Optional Backside pin or magnet attachment.

73 x 38 mm

Sublimation

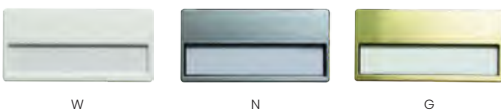

2032

Window Insert Reusable Insert Name Badge with a window area of 63 x 13 mm. Optional Backside pin or magnet attachment.

68 x 33 mm

Screen Printing, UV Printing

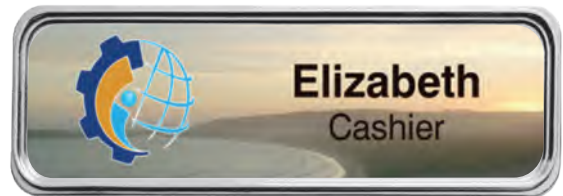

2063-N
78 x 27 mm

2087
72 x 17 mm

Metal Injected Name Badges. Optional Backside pin or magnet attachment. Can be inserted with metal plate.

Sublimation on metal plate, Digital Printing with Epoxy



INB-09

Lens Cover Oval Name Badges.
Optional Backside pin or magnet attachment.

68 x 45 mm

Sublimation



INB-03

Lens Cover Rectangular Name Badges.
Optional Backside pin or magnet attachment.

80 x 30 mm

Sublimation

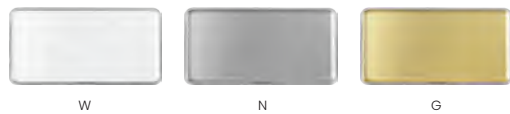

INB-08

Lens Cover Rectangular Name Badges.
Optional Backside pin or magnet attachment.

80 x 40 mm

Sublimation



INB-7000
Window Insert Plastic Reusable Name Badges.
Plastic Base with Backside Magnet attachment.

65 x 30 mm Digital Printing

INB-7001
Window Insert Plastic Reusable Name Badges.
Plastic Base with Backside Magnet attachment.

78 x 32 mm Digital Printing

Plastic Border in Black colour

Pin or magnetic fasteners are guaranteed to hold the name badges in places.

Sublimation aluminum plate, bend resistant and made to last.

W N G

INB-12
Rectangular Plastic Base Name Badges with Aluminum Plate.
Optional Backside pin or magnet attachment.

80 x 30 mm Sublimation



2062

PVC Injected Oval Name Badges.
Optional Backside pin or magnet attachment.

80 x 25 mm

Digital Printing with Epoxy.



2059-G
70 x 35 mm.

2060-G
60 x 30 mm.

2061-G
40 x 20 mm.

Gold PVC Injected Oval Name Badges.
Optional Backside pin or magnet attachment.

Avail in 3 sizes

Digital Printing with Epoxy.

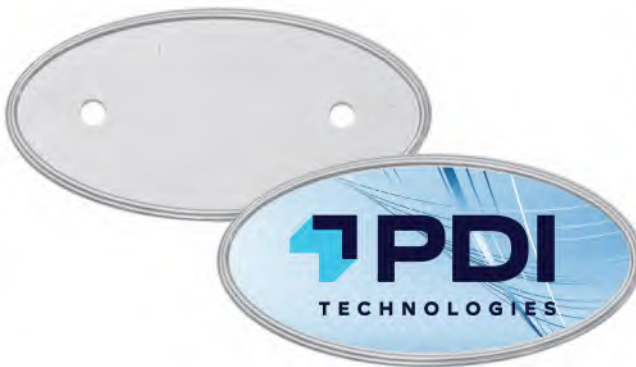

2059-N
70 x 35 mm.

2060-N
60 x 30 mm.

2061-N
40 x 20 mm.

Silver PVC Injected Oval Name Badges.
Optional Backside pin or magnet attachment.

Avail in 3 sizes

Digital Printing with Epoxy.

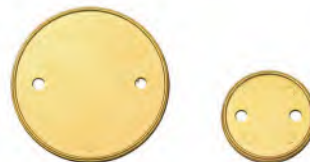

2056-G
50 mm.

2058-G
30 mm.

Gold PVC Injected Round Name Badges.
Optional Backside pin or magnet attachment.

Avail in 2 sizes

Digital Printing with Epoxy.

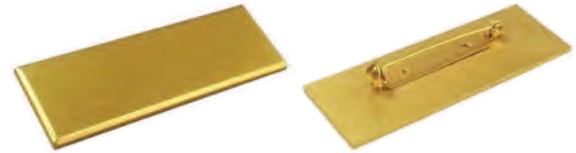

LP-EA001

Gold Brass Name Badges with Safety Pin. Best option for laser engraving when imprinting a logo to showcase a black underneath output.

 60 x 20 mm

 Laser Engraving

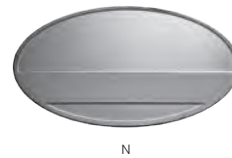

2076

Metal Oval Name Badges. Optional Backside pin or magnet attachment.

 70 x 40 mm

 Digital Printing with Epoxy.

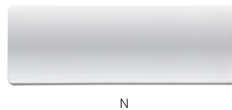

2023

Shiny Metal Name Badges. Optional Backside pin or magnet attachment.

 75 x 25 mm

 Digital Printing with Epoxy.



2019

Matte Aluminum Name Badges. Optional Backside pin or magnet attachment.

 75 x 25 mm

 Digital Printing with Epoxy.



LP-EA001

Gold Pin Badges. Manufactured using durable metal. Creative and bright item. Comes with two pins for attaching.

 87 x 24 mm

 Digital Printing with Epoxy Coating



INB-07

Reusable Acrylic Name Badges. Backside with clip and pin attachment.

 50 x 40 mm

 Digital Printing



INB-04

Reusable Acrylic Name Badges. Backside with pin or magnet attachment.

 75 x 40 mm

 Digital Printing



INB-02

Reusable Acrylic Name Badges. Backside with pin or magnet attachment.

 70 x 25mm

 Digital Printing



INB-06

Reusable Acrylic Name Badges. Backside with pin or magnet attachment.

 70 x 25 mm

 Digital Printing

Engravable PVC Name Badges

(suitable for Laser Engraving to reveal the underneath colour)

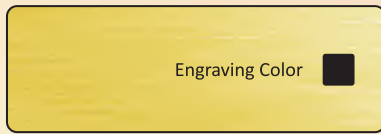

2021BMG-BK
Matt Gold / Black
Size : 75 x 25 mm



2021BSG-BK
Shiny Gold / Black
Size : 75 x 25 mm



2021SMG-BK
Matt Gold / Black
Size : 68 x 17 mm

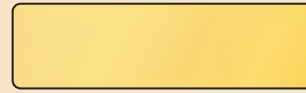

2021SSG-BK
Shiny Gold / Black
Size : 68 x 17 mm

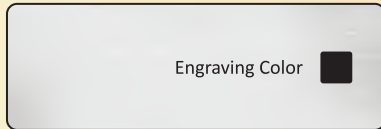

2021BMS-BK
Matt Silver / Black
Size : 75 x 25 mm

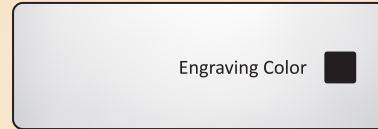

2021BSS-BK
Shiny Silver / Black
Size : 75 x 25 mm

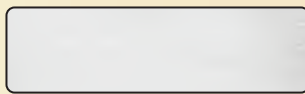

2021SMS-BK
Matt Silver / Black
Size : 68 x 17 mm

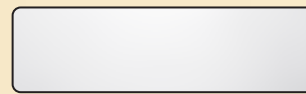

2021SSS-BK
Shiny Silver / Black
Size : 68 x 17 mm



2021BW-R
White / Red
Size : 75 x 25 mm

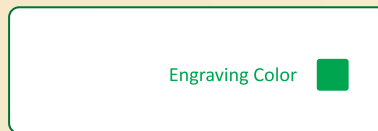

2021BW-GR
White / Green
Size : 75 x 25 mm



2021SW-R
White / Red
Size : 68 x 17 mm



2021SW-GR
White / Green
Size : 68 x 17 mm

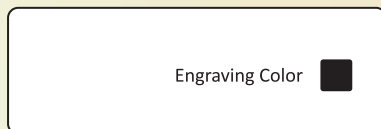

2021BW-BK
White / Black
Size : 75 x 25 mm



2021BY-BK
Yellow / Black
Size : 75 x 25 mm



2021SW-BK
White / Black
Size : 68 x 17 mm

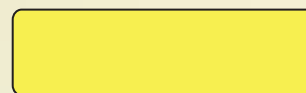

2021SY-BK
Yellow / Black
Size : 68 x 17 mm

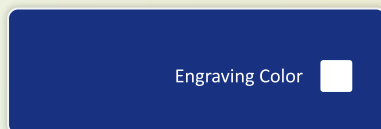

2021BBL-W
Blue / White
Size : 75 x 25 mm

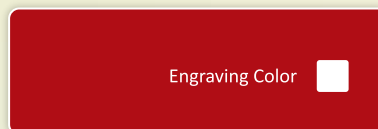

2021BR-W
Red / White
Size : 75 x 25 mm

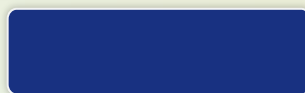

2021SBL-W
Blue / White
Size : 68 x 17 mm



2021SR-W
Red / White
Size : 68 x 17 mm

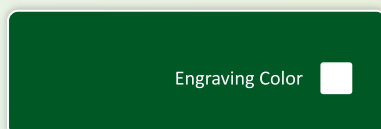

2021BGR-W
Green / White
Size : 75 x 25 mm

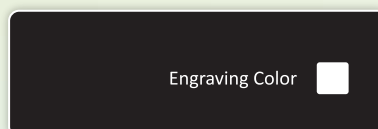

2021BBK-W
Black / White
Size : 75 x 25 mm



2021SGR-W
Green / White
Size : 68 x 17 mm

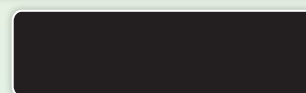

2021SBK-W
Black / White
Size : 68 x 17 mm

Custom-made Bamboo Name Badges

Create your own shape and sizes

Also Offering our Selection of - **READY MADE SHAPE NAME BADGES**



Product Size : 75 x 25 mm, Thickness : 3 mm
Backside magnet attachment



Product Size : 75 x 20 mm, Thickness : 3 mm
Backside magnet attachment



Product Size : 75 x 30 mm, Thickness : 3 mm
Backside magnet attachment



Product Size : 75 x 30 mm, Thickness : 3 mm
Backside magnet attachment



Product Size : 75 x 20 mm, Thickness : 3 mm
Backside magnet attachment



Product Size : 75 x 20 mm, Thickness : 3 mm
Backside magnet attachment



Product Size : 75 x 30 mm, Thickness : 3 mm
Backside magnet attachment



Product Size : 75 x 30 mm, Thickness : 3 mm
Backside magnet attachment



Product Size : 75 x 35 mm, Thickness : 3 mm
Backside magnet attachment



Product Size : 75 x 25 mm, Thickness : 3 mm
Backside magnet attachment



Product Size : 40 mm, Thickness : 3 mm
Backside magnet attachment

Name Badges Accessories

(Backside attachment options)



2016-A
Size : 45 x 13 mm
Magnet accessories



2016-J
Size : 45 x 13 mm
Magnet accessories



2016-C
Size : 45 x 13 mm
Magnet accessories



2016-D
Size : 33 x 13 mm
Magnet accessories



2016-M
Size : 50 x 20 mm
Magnet accessories



2016-O
Size : 20 x 10 mm
Magnet accessories



2016-N / 2016-H
Size : 15 mm / 8 mm
Magnet accessories



2016-K
Size : 30 mm
Magnet accessories



2016-B
Size : 18 mm
Magnet accessories



2016-B-G
Size : 17 mm
Magnet accessories



2015-A
Size : 20 x 7 14 mm
Clip accessories



2015-B
Size : 15 x 20 mm
Clip accessories



2015-D
Size : 15 x 25 mm
Clip & Pin accessories



2015-K
Size : 38 x 5 mm
Pin accessories



2015-P
Size : 55 mm
Pin accessories



2015-Q
Size : 40 mm
Pin accessories



2015-32
Size : 32 mm
Pins with or without 3m Tape



2015-38
Size : 38 mm
Pins with or without 3m Tape



2015-50
Size : 50 mm
Pins with or without 3m Tape



2015-G
Size : 10 mm
Gold Butterfly Clutch



2015-S
Size : 18 mm
Silver Butterfly Clutch



2015-M
Size : 50 x 10 mm
Gold Butterfly Clutch

Lanyards

With their versatile designs and customizable options, id lanyards not only offer functionality but also act as a fashion statement.



Custom-made Sublimation Lanyards

Customize your own Lanyards

Full color printing

Edge to edge printing in single or full colour process in CMYK with no colour restrictions.

Your choice of accessories

Choose from our selection of clips and add-ons as per your requirement.

Lanyard Details

Polyester - Soft in Touch it is a smooth, comfortable, and economical material

Clip options



Silver Trigger Hook



Black Trigger Hook



Oval Hook



Crocodile Clip



Carabiner



Bottle Opener



Retractable Reel Badge

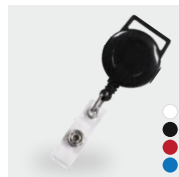

Round Shaped Reel Badge

Add-on options



Buckle



Safety Lock



Mobile Holder

Huge step forward on the path toward a greener, safer and cleaner future.



Recycled plastic bottles made into finely weaved yarn for lanyards

RPET stands for recycled polyethylene terephthalate, or recycled PET. PET is a strong, durable and recyclable material that is used for soda bottles, water bottles and food jars, while RPET can be made into such products as blankets, insulation, car parts, shoes and more. RPET is produced by collecting, sorting and recycling PET, then refining the material into flakes that can be turned into new products. Using RPET as an alternative to PVC is a huge step forward on the path toward a greener, safer and cleaner future.

Custom-made RPET Lanyards

Customize your own Lanyards

Full color printing

Edge to edge printing in single or full colour process in CMYK with no colour restrictions.

Your choice of accessories

Choose from our selection of clips and add-ons as per your requirement.

Lanyard Details

Polyester - Soft in Touch it is a smooth, comfortable, and economical material

Clip options



Silver Trigger Hook



Black Trigger Hook



Oval Hook



Crocodile Clip



Carabiner



Bottle Opener



Retractable Reel Badge

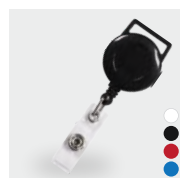

Round Shaped Reel Badge

Add-on options



Buckle



Safety Lock



Mobile Holder

Lanyard have become a ubiquitous accessory in many different environments, and they offer numerous benefits to their wearers.



Custom-made Double Hook Lanyards

Customize your own Lanyards

Full color printing

Edge to edge printing in single or full colour process in CMYK with no colour restrictions.

Your choice of accessories

Choose from our selection of clips and add-ons as per your requirement.

Lanyard Details

Polyester - Soft in Touch it is a smooth, comfortable, and economical material

i Add on option for your lanyard.



i Optional Clips for your lanyard.



Sublimation Lanyards

They are printed on smooth polyester material through digital dye sublimation on one or two side printing.



The custom printed lanyards are your perfect choice to display your Design or Logo in full colour.

CW



HW



LN-002

20mm Lanyard with Buckle.
Available in Clip type & Hook type

 20 x 900 mm

 Sublimation



CW



HW



LN-004

20mm Lanyard with Safety Lock.
Available in Clip type & Hook type
with Mobile Holder.

 20 x 900 mm

 Sublimation



LN-005-CW

15mm Standard Lanyard with Clip
and Mobile Holder.

 15 x 900 mm

 Sublimation



LN-009

RPET Lanyard. Made from recycled materials. Oval hook with Safety lock. Our imprinted lanyards with hooks are of the highest quality, recyclable, and durable

20 x 900 mm

Heat Transfer, Screen Printing



LN-010

Organic Cotton Lanyard. Made from recycled materials. Oval hook with Safety lock. These are a great option for eco-friendly events.

20 x 900 mm

1 color Screen Printing



LN-008

20mm Lanyard. Polyester material Lanyard with Reel Badge and Safety lock. Reel Badge has a 20mm Round Area for full colour printing with epoxy.

20 x 900 mm

Lanyard : Screen Printing
Reel Badge : Digital Printing

W BK R BL



LN-011

15mm Lanyard. Polyester material with Crocodile Hook, Safety Lock & Mobile Holder, Available in 12 different colours.

15 x 900 mm

Heat Transfer, Screen Printing

| | | | | | |
|---|----|----|-----|----|----|
| W | BK | GY | M | R | O |
| Y | BG | GR | SBL | RB | NB |



LN-013

15mm Lanyard. Polyester material with Crocodile Hook & Mobile Holder, with a 17mm Round plastic area for your logo. Available in 12 different colours.

15 x 900 mm

Lanyard : Screen Printing
Logo Badge : Digital Printing

| | | | | | |
|---|----|----|-----|-----|-----|
| W | BK | GY | M | R | OR |
| Y | BG | GR | SBL | RBL | DBL |



LN-003

20mm Lanyard. Polyester material with Trigger Hook, Safety Lock & Buckle. Available in 12 different colours.

20 x 900 mm

Heat Transfer, Screen Printing

| | | | | | |
|---|----|----|-----|-----|-----|
| W | BK | GY | M | R | OR |
| Y | BG | GR | SBL | RBL | DBL |

Promotional Reel Badges

A case that contains a retractable cord for your ID. This cord connects to a badge holder. It has basic form and has a clip on the back for attaching the badge reel to clothing or things.



123

Rotating Reel Badge with clear strap for ID. Backside metal clip rotates at 360°

32 mm (dia)

Digital Printing with Epoxy



124

Metal Reel Badge. Metal reel badge with slide-type clip and clear strap.

32 mm (dia)

Digital Printing with Epoxy



Backside metal clip rotates at 360°





127



Carabiner Reel Badge. Round carabiner push-type clip and clear belt strap for ID.



32 mm (dia)

Digital Printing with Epoxy



125
 Round Reel Badge. Round plastic center logo reel badge with clear belt strap for ID.
 32 mm (dia)
 Digital Printing with Epoxy

126
 Square Reel Badge. Square Plastic with center logo area reel badge, includes clear belt strap for ID.
 32 x 32 mm
 Digital Printing with Epoxy

128
 Round Big Logo Reel badge. Round plastic center logo reel badge with clear belt strap for ID.
 32 mm (dia)
 Digital Printing with Epoxy

ID Card Holders

One way to ensure that your ID card is kept safe and easily accessible is by using ID card holders. These accessories not only protect your ID card from damage but also make it convenient to carry around.



272

Clear Plastic ID Card Holder. For Vertical ID cards. These are ideal for your company's official occasions or in an exhibition.

 Actual Size : 112 x 174 mm, Card Size : 105 x 150 mm



271-H

Clear Plastic ID Card Holder. For Horizontal ID cards. Transparent and clear. Perfect for professional use.

 105 x 115 mm



268

Rigid Flexible PVC ID Card Holders. For Vertical and Horizontal ID cards. Ideal for a range of occasions, including field trips, performances, gatherings, and group outings.

 58 x 90 mm

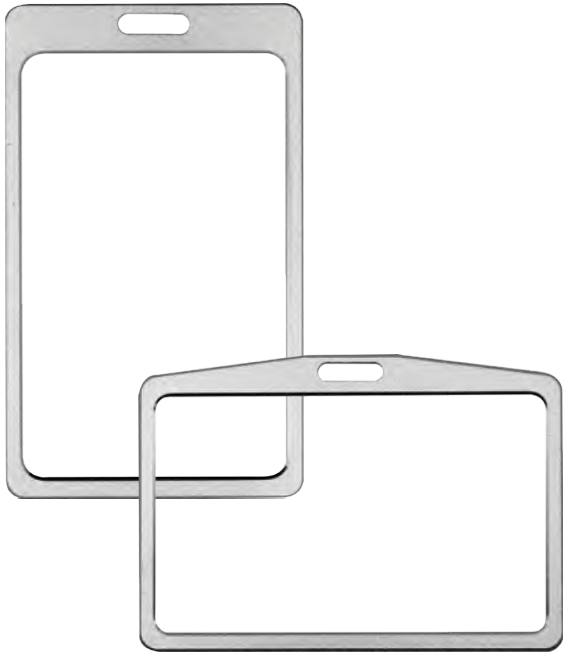

CH-004

Aluminum ID Card Holders. The ID card holder comes in both horizontal and vertical configurations. Holds your cards in place and last for a long time due to sturdy material.

 Vertical : 60 x 98 mm, Horizontal : 92 x 64 mm



CH-002

Two Sides ID Card Holder. For Vertical and Horizontal ID cards. The cardholder is made exclusively of plastic. Can store 2 cards at once.

 105 x 65 mm



CH-003

Clear Rigid PVC Card Holder. For Both Vertical & Horizontal ID cards. Made of PVC. Long-lasting. Decent protection for your ID cards.

 95 x 65 mm





269



Semi-Flexible PVC ID Card Holders. For Vertical and Horizontal ID cards. Open-face design with frosted texture.

 95 x 65 mm



CH-006-BK

PU Leather Foldable ID Card Holder with Lace & Hook. Protective and convenient. Clear window ID slots on the front & another slot on the other side for other cards

 ID Holder : 75 x 110 x 6 mm,
 Lace : 44 cm long and 1.5 cm wide hook-type



AWARDS AND PLAQUES

We offer a wide collection of Awards & Plaques. We offer it on different printing method such as; Sublimation, Sandblasting, 2D/3D Laser Engraving and Fully Customized Cutting.



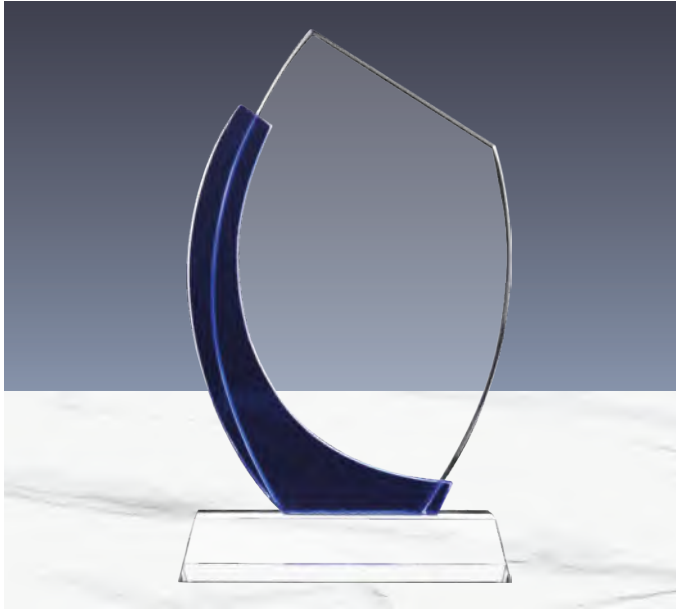

CR-15

Crystal Award with Blue Design on the Side.
Packed in Luxury Wooden Box.



Available in 3 sizes



Laser Engraving,
Sandblast sticker

| | |
|---------|--------------|
| CR-15-S | 150 x 260 mm |
| CR-15-M | 180 x 280 mm |
| CR-15-L | 210 x 350 mm |



CR-27

Crystal Award with Blue Base.
Packed in Cardboard Box.



Available in 3 sizes



Laser Engraving,
Sandblast sticker

| | |
|---------|-------------------|
| CR-27-S | 150 x 185 x 57 mm |
| CR-27-M | 150 x 205 x 57 mm |
| CR-27-L | 150 x 225 x 57 mm |

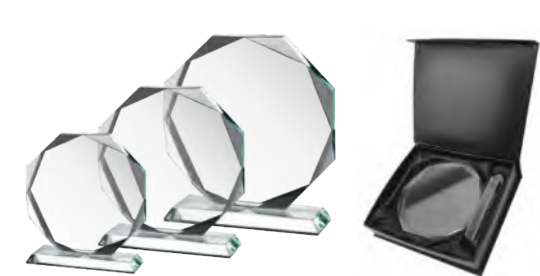
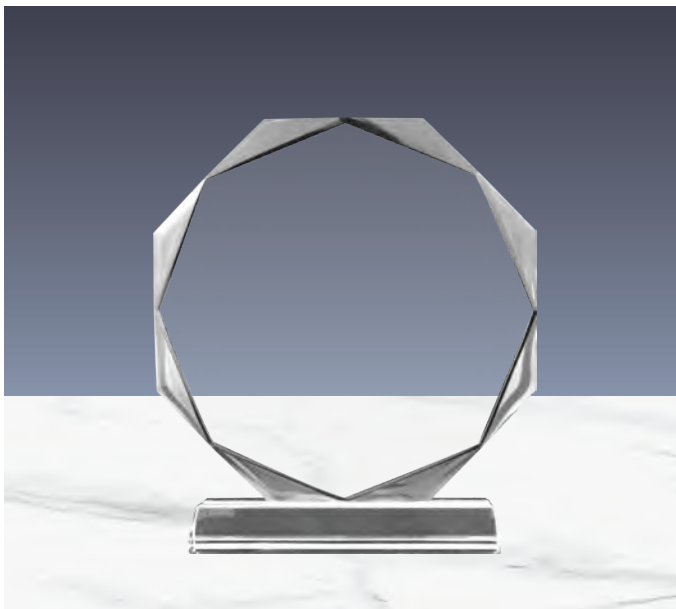

CR-07

Round Crystal Award. Has a beautiful appearance thanks to
laser cutting technology. Packed in Cardboard Box.



Available in 3 sizes



Laser Engraving,
Sandblast sticker

| | |
|---------|--------------|
| CR-07-S | 100 x 120 mm |
| CR-07-M | 150 x 170 mm |
| CR-07-L | 180 x 200 mm |



CR-60

Crystal Trophy with black cylinder base. Packed in Luxury Wooden Box.

 80 x 200 x 80 mm

 Laser Engraving,
DTF Printing



CR-13

Star Crystal Trophy. This star-shaped crystal trophy has several intricately carved details. Packed in Luxury Wooden Box.

 80 x 80 x 270 mm

 Sublimation on plate
fixed on the base.



CR-12

Crystal Globe Trophy. The globe trophy is incredibly beautiful and elegant due to its golden tint. Packed in Luxury Wooden Box.

 80 x 80 x 300 mm

 Sublimation on plate
fixed on the base.



CR-04

Crystal Award with Black Base. Elegant appearance and original design. The perfect option for any occasion. Packed in Luxury Wooden Box.

 180 x 240 mm

 Laser Engraving,
Sandblast sticker,
Sublimation on plate



CR-01

Square-Shaped Crystal Awards. Design is characterized by their sophistication and elegance. Packed in Fiber Hardboard Box.

 148 x 150 x 30 mm

 Laser Engraving,
Sandblast sticker,
DTF Printing, UV Printing



CR-05

Crystal Award with Black Base. Elegant appearance and original design. The perfect option for any occasion. Packed in Luxury Wooden Box.

 130 x 190 mm

 Laser Engraving,
Sandblast sticker,
Sublimation on plate

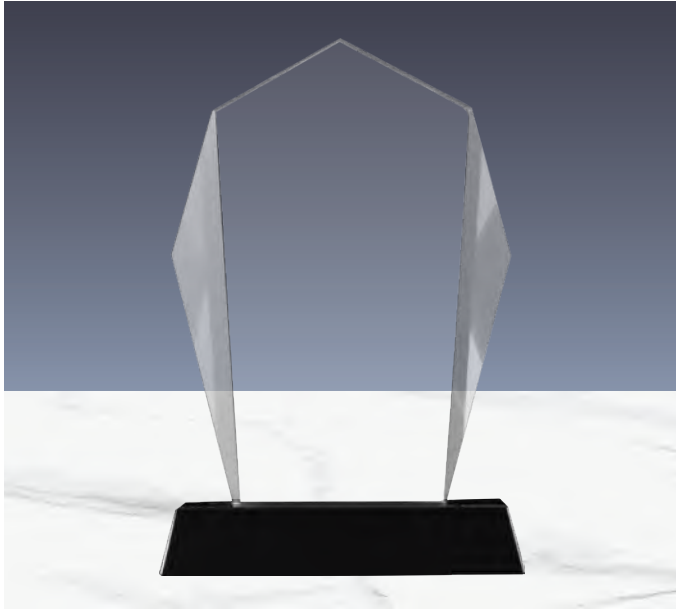

CR-09

Crystal Award with Black Base. Multi-faceted optical design is made of premium crystal glass. Has a flawless appearance thanks to laser cutting. Packed in Luxury Wooden Box.

 160 x 230 mm

 Laser Engraving,
Sandblast sticker,
Sublimation on plate



CR-10

UAE Falcon Crystal. This design features a falcon in the midst of the UAE flag. Made from bright, translucent crystal. Packed in Luxury Wooden Box.

 163 x 243 mm

 Laser Engraving on the
base metal plate



TR-01

UAE Golden Dhow Memento in Wooden Base & Acrylic Case. Features a dhow crafted from high-quality material and gold-plated metal, showcasing intricate details.

 230 x 210 x 105 mm

 Sublimation Printing
on base, UV DTF Printing



CR-40

Flame Shaped Crystal Awards with Glass base. Ideal for praising exceptional performance at events and contests. Packed in the black carton gift box.

 90 x 237 x 53 mm

 Laser Engraving,
Sandblast sticker,
Sublimation Printing



CR-41

Wide Flame Crystal Awards with Glass base. An eye-catching prizes that reflect the status of your most notable winners. Packed in the black carton gift box.

 133 x 210 x 43 mm

 Laser Engraving,
Sandblast sticker,
Sublimation Printing



CR-42

Hexagon Shaped Crystal Awards with Glass Base. Hexagonal column is set on a beveled glass base and is supported by a circular collar. Packed in the black carton gift box.

 87 x 242 x 53 mm

 Laser Engraving,
Sandblast sticker,
Sublimation Printing



CR-43

Rectangle Crystal Awards with Glass base. Make one-of-a-kind awards to recognize significant members of your organization. Packed in the black carton gift box.



150 x 195 x 41 mm



Laser Engraving,
Sandblast sticker,
Sublimation Printing



CR-44

Crystal Awards with Engraved Leaf Design. An asymmetric plaque decorated with leaves in grey and silver. Packed in the black carton gift box.



150 x 220 x 43 mm



Laser Engraving,
Sandblast sticker,
Sublimation Printing



CR-45

Rhombus Shaped Crystal Awards with Engraved Design. A traditional diamond-shaped crystal trophy with faceted edges. Packed in the black carton gift box.



175 x 195 x 40 mm



Laser Engraving,
Sandblast sticker,
Sublimation Printing



CR-46

Victorian Shield Crystal Awards. Packed in the black carton gift box.

 145 x 180 x 43 mm



Laser Engraving,
Sandblast sticker,
Sublimation Printing



CR-47

Shield Shaped Crystal Awards. It is supported by a substantial glass base and has a sizable engraving area. Packed in the black carton gift box.

 130 x 175 x 45 mm



Laser Engraving,
Sandblast sticker,
Sublimation Printing



CR-48

Tower Shaped Crystal Awards, Clear & Red Design. Elegant and eye-catching recognition piece. Packed in the black carton gift box.

 122 x 260 x 41 mm





Laser Engraving,
Sandblast sticker,
Sublimation Printing



CR-200

Crystal Diamond Awards paperweight style. Elegant clear diamond that is perfect for gift & advertising with your message. Packed in the black carton gift box.

 80 x 80 x 50 mm

 Laser Engraving,
Sandblast sticker,
DTF Printing

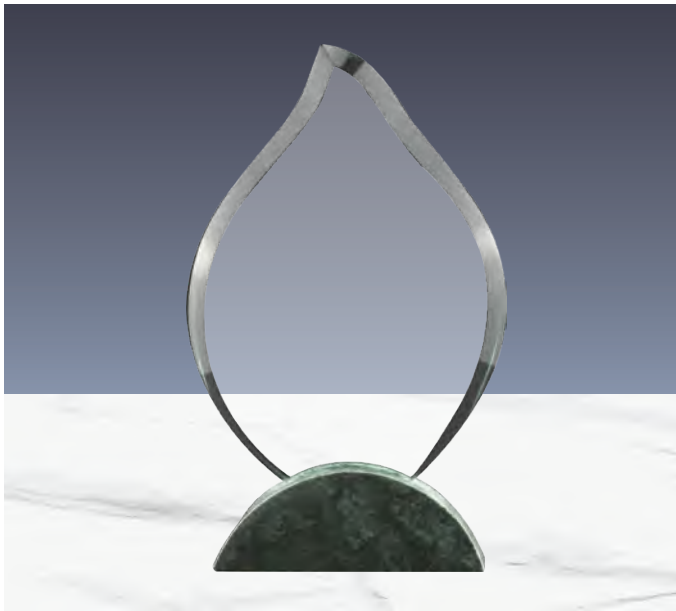

CR-34

Flame Shaped Crystal & Marble Awards. A classy and sophisticated option. Presented on a Luxury Hardboard Box.

 135 x 225 x 40 mm

 Laser Engraving,
Sandblast sticker

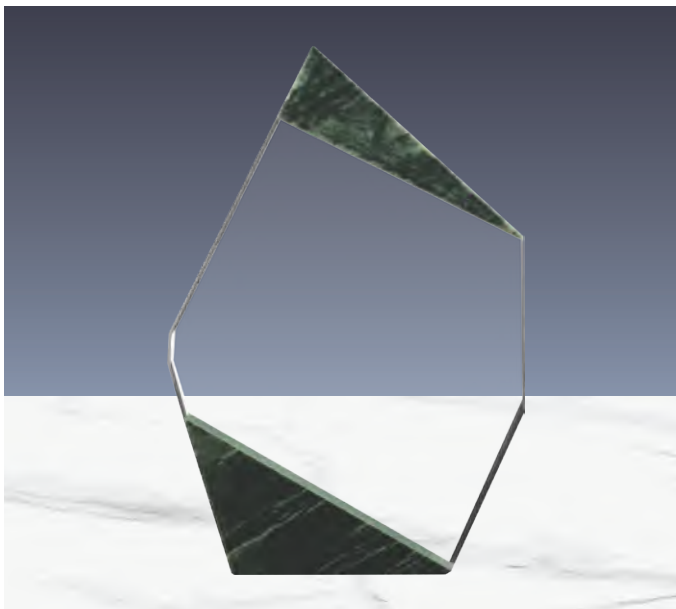

CR-35

Crystal & Marble Awards. A classy and sophisticated option. Presented on a Luxury Hardboard Box.

 143 x 210 x 29 mm

 Laser Engraving,
Sandblast sticker

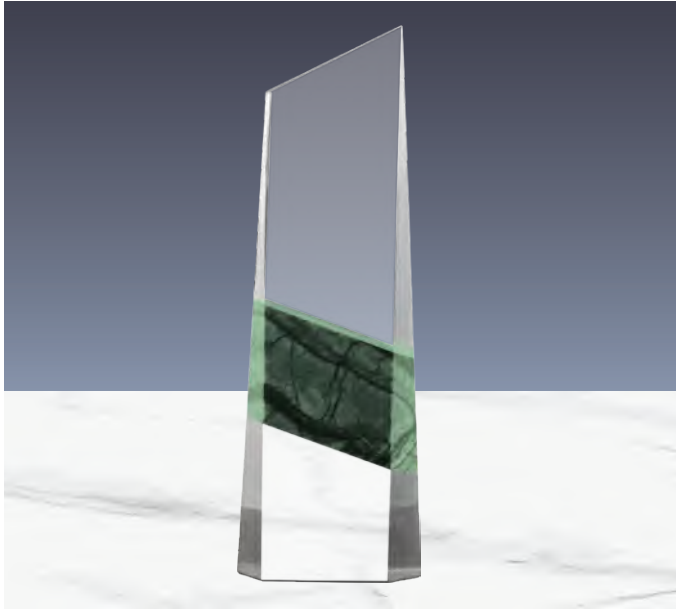

CR-36

Vertical Crystal and Marble Awards. Refined and elegant may be accomplished through vertical design. Presented on a Luxury Hardboard Box.

 90 x 270 x 40 mm

 Laser Engraving,
Sandblast sticker

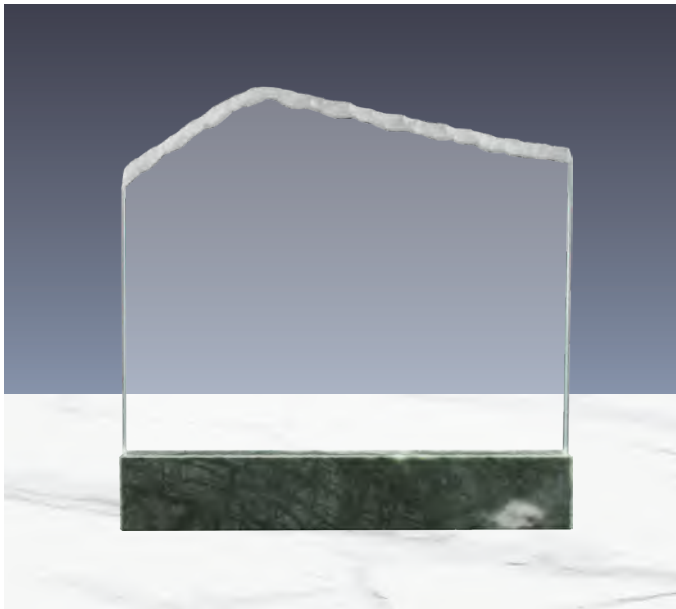

CR-37

Crystal and Marble Awards. Everlasting elegance with a large area for your message. Presented on a Luxury Hardboard Box.

 188 x 187 x 38 mm

 Laser Engraving,
Sandblast sticker

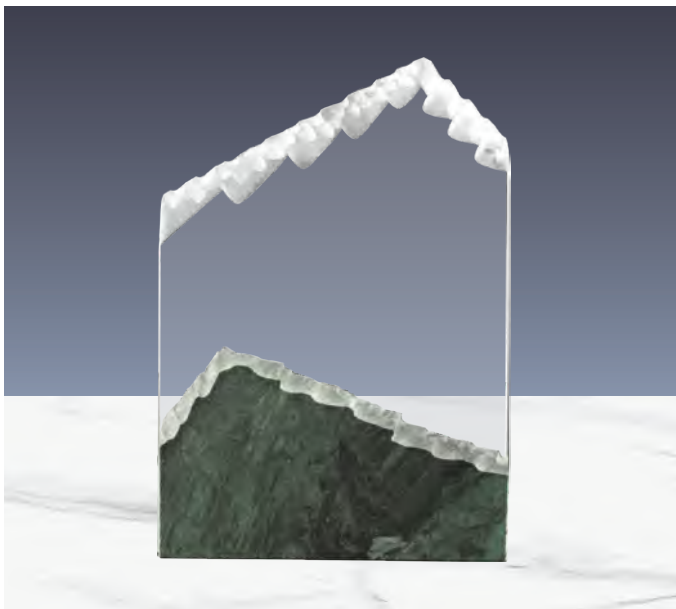

CR-38

Crystal and Marble Awards. Presented on a Luxury Hardboard Box.

 170 x 250 x 22 mm

 Laser Engraving,
Sandblast sticker

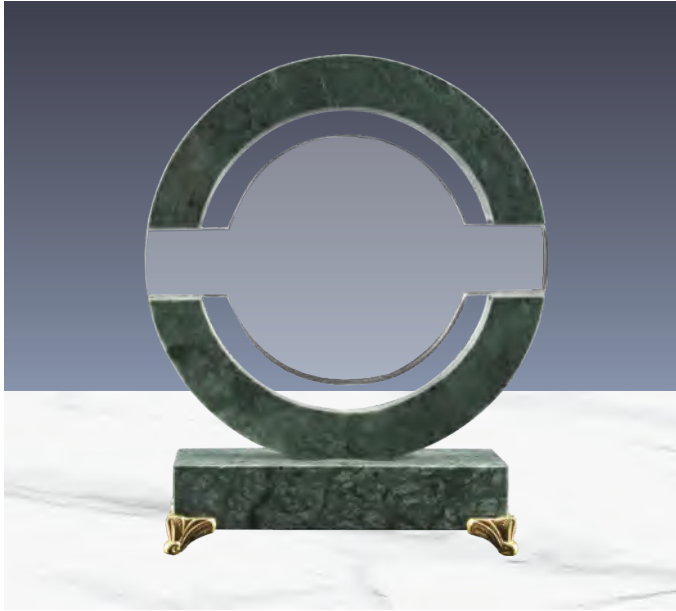

CR-39

Round Crystal and Marble Awards.
Presented on a Luxury Hardboard Box.

 180 x 205 x 45 mm

 Laser Engraving,
Sandblast sticker

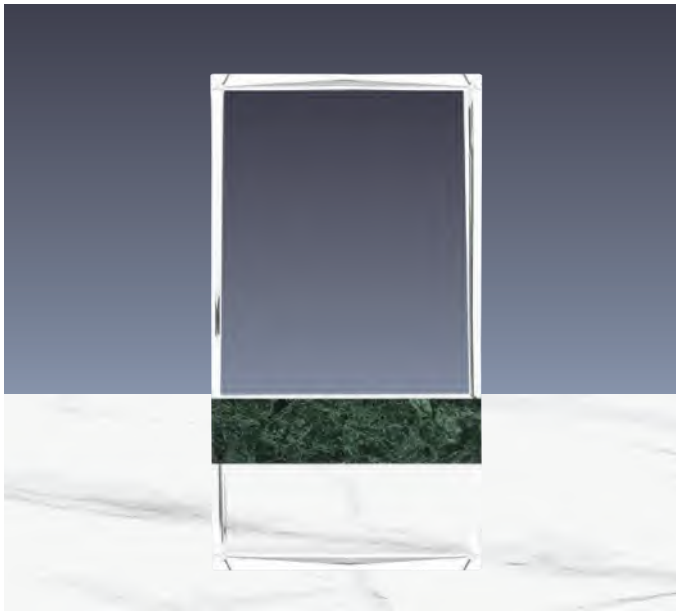

CR-49

Rectangular Crystal and Marble Awards.
Presented on a Luxury Wooden Box.

 121 x 231 x 28 mm

 Laser Engraving,
Sandblast sticker

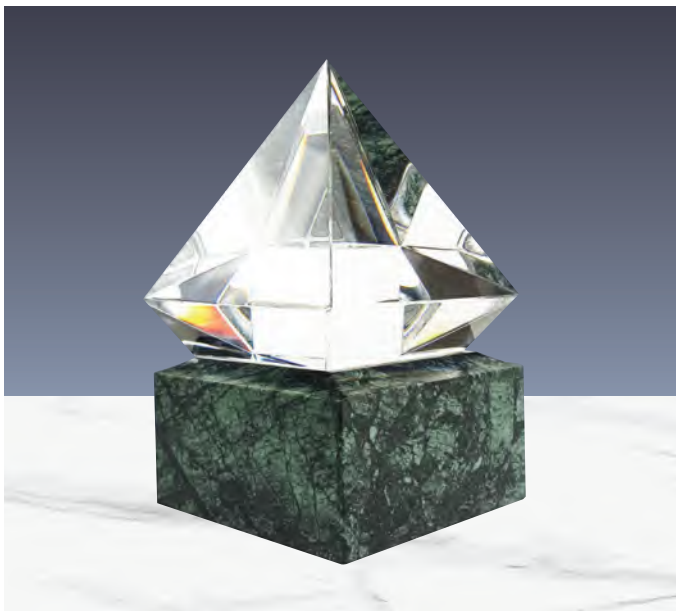

CR-50

Diamond Shaped Crystal Awards with Marble Base.
Presented on a Luxury Wooden Box.

 120 x 230 x 30 mm

 Laser Engraving,
Sandblast sticker,
Sublimation on plate

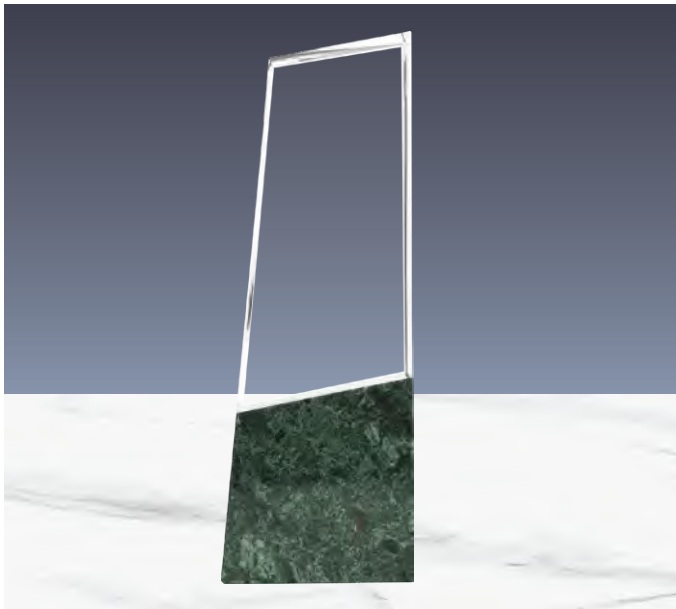

CR-51

Crystal & Marble Award. Vertical design with a slight inclined style. Presented on a Luxury Wooden Box.

82 x 241 x 24 mm

Laser Engraving, Sandblast sticker

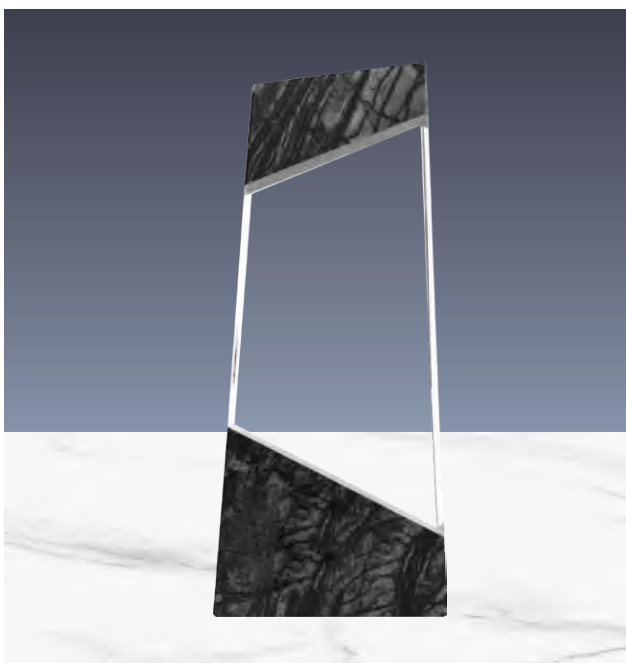

CR-52

Crystal Awards Top & Bottom Marble Design. This is a priceless gift that may be used to present medals and trophies. Presented on a Luxury Wooden Box.

95 x 218 x 27 mm

Laser Engraving, Screen Printing



CR-63

Wooden Trophy with Diamond shape Crystal on Top. Packed in a vertical opening Black Hardboard box with black velvet interior and gold lock.

75 x 75 x 280 mm

Laser Engraving, DTF Printing



CR-53

Star Design Wooden Trophy Award. Packed in a brown with a yellow color Carton gift box with one side magnetic opening.



142 x 243 x 20 mm



Laser Engraving,
Screen Printing,
Sublimation on plate



CR-54

Rectangle Shaped Wood and Crystal Awards. Ideal way to reward your team, staff, customers, and partners while also boosting the recognition. Packed in a Black carton gift box.



120 x 200 x 35 mm



Laser Engraving,
Screen Printing



CR-55

Star Shaped Crystal Awards. The excellence, brilliance, and relevancy of the recipient's achievements are eloquently expressed in these award. Packed on a Luxury Wooden Box.



200 x 230 x 40 mm



Laser Engraving,
Sandblast sticker,
Sublimation on plate



CR-56

Square Crystal Awards with Wooden Base. Exudes a sense of harmony while also evoking stability and robustness. Packed on a Luxury Wooden Box.



150 x 180 x 35 mm



Laser Engraving



CR-57

Round Moon Crystal Awards with a Wooden base. Striking symbols of esteem and distinction. Packed on a Luxury Wooden Box.



150 x 195 x 45 mm



Laser Engraving,
Sublimation on plate



CR-58

Tower-shaped crystal awards with wooden base. Beautiful and well-respected symbols of success and honor. Packed on a Luxury Wooden Box.



105 x 270 x 40 mm



Laser Engraving,
Sandblast sticker,
Sublimation on plate



CR-59

Cuboid-shaped crystal awards with wooden base. Distinguishing mementos of acknowledgment and achievement. Packed on a Luxury Wooden Box.

 60 x 50 x 228 mm

 Laser Engraving, Sublimation on plate



CR-61

Rectangle Wooden Crystal Awards. Packed in a vertical opening Black Hardboard box with black velvet interior and gold lock.

 125 x 220 x 35 mm

 Laser Engraving, Sandblast sticker, DTF Printing



CR-62

Crystal Awards with Wooden Base. Packed in a vertical opening Black Hardboard box with black velvet interior and gold lock.

 140 x 240 x 40 mm

 Laser Engraving, Sandblast sticker, DTF Printing

Crystals Awards for Laser Engraving

Innovatively combining the world's most advanced high-resolution 2D / 3D laser engraving technology with exceptional artistry.



Laser Engraving Service

Engrave your Corporate Logo, Memorable Events or even your Personal photos.

- ⌚ High Speed Engraving
- ⌚ Fast Production time
- ⌚ Applicable on other materials
- ⌚ High Accuracy, Perfect Images
- ⌚ Presentable output
- ⌚ Affordable Prices



3D Cube Crystals. Prized for their stunning clarity, substantial weight, and timeless quality. Packed in a Cardboard Box.

 Available in 2 sizes  2D/3D Laser Engraving

| | |
|-------|-----------------|
| CR-23 | 60 x 60 x 60 mm |
| CR-24 | 80 x 80 x 80 mm |



3D Rectangular Crystals. Ideal for usage in trophies, employee rewards, paperweights, corporate gifts, and other memorable products. Packed in a Cardboard Box.

 Available in 2 sizes  2D/3D Laser Engraving

| | |
|-------|------------------|
| CR-25 | 80 x 50 x 50 mm |
| CR-26 | 120 x 80 x 60 mm |



207

Semi Circle Crystals. Complex D-shaped pattern.. Ideal business gift for company events.

 157 x 76 mm

 Laser Engraving



211

Inclined Rectangular Crystal Award. Ideal for your business or honoring a significant occasion.

 60 x 80 mm

 Laser Engraving



212

Inclined Round Crystal Award. Traditional and fashionable trophy. It is a self-sustaining honorarium.

 86 x 80 mm

 Laser Engraving



206-F

Crystal with 2 Round corner. Large surface area for printing pictures, logos, and creative designs.

 150 x 100 mm

 Sublimation



210-F

Round Photo Crystals. Fantastic unique present for everyone. Elegant, detailed sunflower pattern.

 165 x 150 mm

 Sublimation



209-F

Rectangular Crystals. Wonderful when used to beautify a space and add beauty to the decor.

 60 x 80 mm

 Sublimation





214-F

Diamond shaped Photo Crystal. A fantastic present for everyone.

 130 x 210 mm

 Sublimation



215-F

Rectangular Photo Crystal. A unique honor and gift for deserving individuals.

 150 x 190 mm

 Sublimation



216-F

Heptagon shaped Photo Crystal. Large surface for printing pictures, logos, and creative designs.

 130 x 200 mm

 Sublimation



217-F

Rectangular Photo Crystal. Crystal with excellent photo custom edges. Ideal for business gift or events.

 100 x 190 mm

 Sublimation



226-F

Heart Shaped Photo Crystal. Wonderful present idea for everyone and for your loved ones.

 110 x 115 mm

 Sublimation



222-F

Rectangular Photo Crystal. Durable and long-lasting product. Ideal gift for memorable events.

 180 x 230 mm

 Sublimation

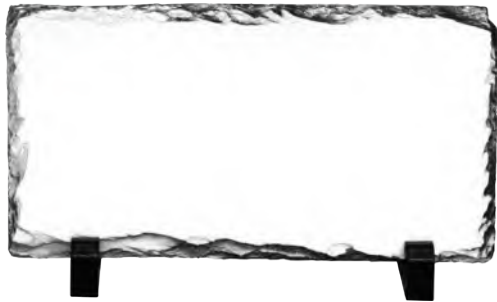

203

Sublimation Photo Rock with display stand. Ideal business gift for company events. Packed in a Cardboard Box.



200 x 120 mm



Sublimation



204

Sublimation Photo Rock with display stand. Fashionable elaborate rectangular design. Packed in a Cardboard Box.



260 x 180 mm



Sublimation



201

Sublimation Photo Rock with display stand. An elegantly complex, curving design. Packed in a Cardboard Box.



200 x 200 mm



Sublimation



202

Sublimation Photo Rock with display stand. Fashionable square design. Packed in a Cardboard Box.



200 x 200 mm



Sublimation



205

Sublimation Photo Rock with display stand. Intricate curved shape design. Packed in a Cardboard Box.



200 x 200 mm



Sublimation



WPL-06-V

Portrait Wooden Plaques with Box. Vertical Plaque in matte finish and Aluminum Plate for your full color printing. Packed in a matte luxury wooden box with velvet.

 90 x 237 mm

 Sublimation



WPL-06-H

Landscape Wooden Plaques with Box. Horizontal Plaque in matte finish and Aluminum Plate for your full color printing. Packed in a matte luxury wooden box with velvet.

 237 x 190 mm

 Sublimation

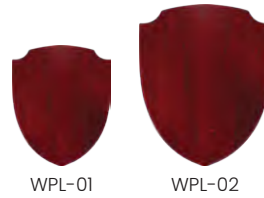

Shield shaped in gloss finish and Aluminium Plate for your full color printing. Packed in a luxury wooden box with velvet.

Available in 2 sizes  Sublimation

| | |
|--------|-------------------------------------------------------|
| WPL-01 | Plaque Size : 170 x 210 mm Box Size : 195 x 235 mm |
| WPL-02 | Plaque Size : 217 x 287 mm Box Size : 245 x 315 mm |

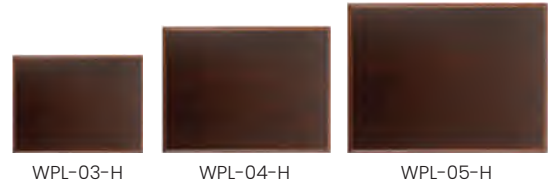

Horizontal Plaque in gloss finish and Aluminium Plate for your full color printing. Packed in a luxury wooden box with velvet.

Available in 3 sizes  Sublimation

| | |
|----------|-------------------------------------------------------|
| WPL-03-H | Plaque Size : 200 x 150 mm Box Size : 225 x 175 mm |
| WPL-04-H | Plaque Size : 255 x 200 mm Box Size : 280 x 225 mm |
| WPL-05-H | Plaque Size : 300 x 230 mm Box Size : 325 x 250 mm |

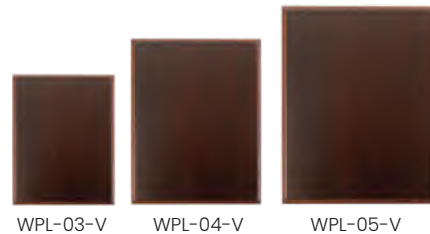

Vertical Plaque in gloss finish and Aluminium Plate for your full color printing. Packed in a luxury wooden box with velvet.

Available in 3 sizes  Sublimation

| | |
|----------|-------------------------------------------------------|
| WPL-03-V | Plaque Size : 150 x 200 mm Box Size : 175 x 225 mm |
| WPL-04-V | Plaque Size : 200 x 255 mm Box Size : 225 x 280 mm |
| WPL-05-V | Plaque Size : 230 x 300 mm Box Size : 250 x 325 mm |



PROMOTIONAL GIFTSETS

One effective strategy that has become increasingly popular is the use of promotional gift sets. These sets offer a unique and personal way to connect with customers and leave a lasting impression.



GS-1

Promotional Gift Set. Black Cardboard gift box with cushion inside for product protection and better presentation.

 170 x 160 x 32 mm  Laser Markings

Product includes :

- > Promotional leather wallet
- > Metal keychain with black leather strap
- > Black & Silver promotional metal pen.



GS-2

Business Card holder & Keychain Gift Set. Black Cardboard gift box with cushion inside for product protection and better presentation.

 144 x 154 x 34 mm  Laser Markings
Screen Printing

Product includes :

- > Business Card Holder
- > Metal keychain with black leather strap.



GS-3

Business Card holder & Keychain Gift Set. Black Cardboard gift box with cushion inside for product protection and better presentation.

 144 x 154 x 34 mm  Laser Markings
Screen Printing

Product includes :

- > Business Card Holder
- > Metal keychain with black leather strap.



GS-4

Business Card holder & Mobile holder Gift Set. Black Cardboard gift box with cushion inside for product protection and better presentation.

 144 x 154 x 34 mm  Laser Markings
Screen Printing

Product includes :

- > Metal Card Holder with RFID Protection
- > Promotional Metal Phone Ring.



GS-05

Promotional Gift Set. Black Cardboard gift box with cushion inside for product protection and better presentation.

 275 x 255 x 45 mm

 Screen Printing, UV Printing
Laser Engraving, Debossing & Foiling

Product includes :

- MB-06-BK: Black A6 size Notebook,
- WM3-BLK: Wireless Slim LED Mouse
- JU-PB-5000-BK: 5000 mAh Powerbank
- PN42-BK: Rubberized Metal Pen with Stylus
- USB-20-BK: Black Slide Button USB Flash 8GB
- GB-L-BLK: Black Cardboard Packing Box



GS-06

Promotional Gift Sets. Natural Cardboard gift box with cushion inside for product protection and better presentation.

 260 x 290 x 105 mm

 Screen Printing, UV Printing

Product includes :

- TM-009: 500ml Stainless steel travel bottle
- MB-05: A5 size PU notebook
- PN42: Metal pen with stylus.
- GB-XL-R: Recycled Cardboard Packing Box



GS-07

Promotional Gift Set. Black Cardboard gift box with cushion inside for product protection and better presentation.

 275 x 255 x 45 mm

 Screen Printing, UV Printing
Laser Marking & Engraving

Product includes :

- MB-06-BK: Black A6 size notebook,
- PN27-BK: Black metal pen with stylus
- BCH-02: Business card holder
- MPS-05-BK: Black mobile phone stand,
- PR-BK: Black metal phone ring
- GB-L-BLK: Black Cardboard Packing Box





GS-08

Promotional Gift Set. Black Cardboard gift box with cushion inside for product protection and better presentation.

 275 x 255 x 45 mm

 Screen Printing, UV Printing
Debossing

Product includes :

- MB-06-W: White A6 size notebook,
- PN26-W: White metal pen with stylus and LED light
- JU-PB-5000-W: 5000 mAh mini powerbank
- MPS-05-W: White mobile phone stand,
- USB-20-W: White slide button USB flash drive 8GB.
- GB-L-BLK: Black Cardboard Packing Box

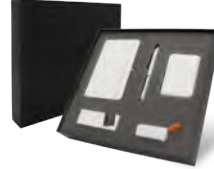

GS-09

Promotional Gift Sets. Black Cardboard gift box with cushion inside for product protection and better presentation. (Optional Black or White series)

 260 x 290 x 105 mm

 Screen Printing, UV Printing
Laser Markings

Product includes :

- MBA5PU: A5 size PU notebook
- PN44: Metal pen with stylus
- TM-043: Double-wall bottle with temp display
- GB-XL-BLK: Black Cardboard Packing Box



GS-010

Black or White combination Eco-Friendly Gift Sets. Natural Cardboard gift box with cushion inside for product protection and better presentation.

 260 x 290 x 105 mm

 Screen Printing, UV Printing
DTF Printing

Product includes :

- TM-010: Travel Tumbler with cork base & clear lid
- 151: Ceramic Mug with cork base
- TM-051: Ceramic Tea cup with cork base
- COA-02: Cork Tea Coasters (3pcs)
- GB-XL-CO: Cork Cardboard Packing Box



GS-011

Cork Gift Set. Black Cardboard gift box with cushion inside for product protection and better presentation.

275 x 255 x 45 mm

Screen Printing, UV Printing

Product includes :

- MB-05-C: A5 size cork notebook
- 071-W: Wheat straw and cork pen
- WPB-CO-8K: 8000 mAh wireless powerbank.
- USB-35-WS: Wheat straw swivel USB 8GB
- GB-L-CO: Cork with Black Cardboard Packing Box



GS-012

Bamboo Gift Sets. Natural Cardboard gift box with cushion inside for product protection and better presentation.

200 x 160 x 43 mm

Screen Printing, UV Printing
Laser Engraving

Product includes :

- JU-WPB-B8000: 8000 mAh wireless powerbank.
- 082-SL: Bamboo pen
- USB-38: Bamboo USB flash drive 8GB
- KH-7-BM: Bamboo keychain
- GB-A5-R: Recycled Cardboard Packing Box.



GS-013

Promotional Gift Set. Black Cardboard gift box with cushion inside for product protection and better presentation.

190 x 165 x 50 mm

Screen Printing, UV Printing
Laser Marking & Engraving

Product includes :

- MPS-05-BK: Black mobile holder,
- PN42-BK: Black metal pen with stylus
- USB-20-BK: Black slide USB flash drive – 8 GB
- AF-001-BK: Black stylus metal pen.
- GB-BK-S: Black Cardboard Packing Box





GS-014

Promotional Gift Set. Black Cardboard gift box with cushion inside for product protection and better presentation.

 275 x 255 x 45 mm

 Screen Printing, UV Printing, Debossing
Laser Markings

Product includes :

- MBA5PU: A5 size Black or White PU Notebook
- PN27: Black or White Pen with stylus
- PB-10K: 10,000 mAh Black or White Powerbank with LED display and built-in cables.
- GB-L-BLK: Black Cardboard Packing Box



GS-015

Bamboo Gift Sets. Black Cardboard gift box with cushion inside for product protection and better presentation.

 420 x 297 x 100 mm

 Screen Printing, UV Printing
DTF Printing, Laser Engraving

Product includes :

- MBBM-BLK-A5: A5 size Bamboo Notebooks
- EFP-100: Bamboo Pens with Stylus
- WM4: Bamboo Wireless Mouse
- USB-75: Light-up logo Bamboo Flash Drive
- TM-024-BK: Black ceramic mug with bamboo
- WDS6-BLK: Wireless charger with pen holder
- GB-A3-BLK: Black Cardboard Packing Box



GS-016

Promotional Gift Sets. Natural Cardboard gift box with cushion inside for product protection and better presentation.

 260 x 290 x 105 mm

 Screen Printing, UV Printing
Laser Markings & Engraving

Product includes :

- TM-015-BK: Black stainless steel bottle
- PB-10K-BLK: Black 10,000 mAh Powerbank
- USB-68: Black metal USB with keyring – 8GB
- PN42-BK: Black rubberized metal pen with stylus.
- GB-XL-R: Recycled Cardboard Packing Box





GS-017

Bamboo Gift Set. Black Cardboard gift box with cushion inside for product protection and better presentation.

275 x 255 x 45 mm

Screen Printing, UV Printing
Laser Engraving

Product includes :

- MBBM-BLK-A5: A5 size Bamboo Notebooks
- EFP-100: Bamboo Pens with Stylus
- WCP-L2: Bamboo Wireless Charger
- WM4: Bamboo Wireless Mouse
- GB-L-BLK: Black Cardboard Packing Box



GS-018

Bamboo Gift Sets. Natural Cardboard gift box with cushion inside for product protection and better presentation.

260 x 290 x 105 mm

Screen Printing, UV Printing
Laser Engraving

Product includes :

- TM-014: Glass and bamboo flask
- LUN-GLB: Glass and bamboo lunch box
- GB-XL-R: Recycled Cardboard Packing Box



GS-019

Bamboo Gift Sets. Natural Cardboard gift box with cushion inside for product protection and better presentation.

260 x 290 x 105 mm

Screen Printing, UV Printing
DTF Printing

Product includes :

- WCP-BM7: Bamboo wireless charger with Mug warmer
- TM-024-BM: Mug with bamboo handle & lid
- WM4: Bamboo Wireless Mouse
- GB-XL-R: Recycled Cardboard Packing Box





GS-020

Cork Gift Set. Cork cover with black base Cardboard gift box with cushion inside for product protection and better presentation.

 275 x 255 x 45 mm

 Screen Printing

Product includes :

- MB-05-C: A5 size Cork cover Notebook
- 071-BK: Cork & Wheat straw Pen
- KH-12-CO: Cork PU Keychain
- BCH-03-C: Cork Card holder with RFID protection
- GB-L-CO: Cork with Black Cardboard Packing Box



GS-021

Cork Gift Sets. Cork Cardboard gift box with cushion inside for product protection and better presentation.

 260 x 290 x 105 mm

 Screen Printing, UV Printing

Product includes :

- MB-05-C: A5 size Cork cover notebook
- 071-BK: Cork and wheat straw pen
- TM-010-BK: Black tumbler with cork base
- GB-XL-CO: Cork Packing Box



GS-022

Cork Gift Sets. Natural Cardboard gift box with cushion inside for product protection and better presentation.

 210 x 160 x 43 mm

 Screen Printings, UV Printing
Laser Markings

Product includes :

- WPB-CO-8K: 8000 mAh wireless powerbank
- PN70: Cork and Metal Pen
- GB-A5-R: Recycled Cardboard Packing Box





GS-023

Cork Gift Sets. Natural Cardboard gift box with cushion inside for product protection and better presentation.

 210 x 160 x 43 mm

 Screen Printing, UV Printing
Laser Markings

Product includes :

- O81: Cork Pen with stylus
- KH-5: Metal keychain with cork strap
- BCH-03-C: RFID Protected cork card holders
- GB-A5-R: Recycled Cardboard Packing Box



GS-024

Bamboo Gift Sets. Natural Cardboard gift box with cushion inside for product protection and better presentation.

 260 x 290 x 105 mm

 Screen Printing, UV Printing
Laser Engraving, DTF Printing

Product includes :

- TM-011: Bamboo Flask
- WCP-03: Bamboo Wireless Charger Stand
- MS-07: Bamboo Bluetooth Speakers.
- GB-XL-R: Recycled Cardboard Packing Box



GS-025

Bamboo Gift Sets. Black Cardboard gift box with cushion inside for product protection and better presentation.

 260 x 290 x 105 mm

 Screen Printing, UV Printing
DTF Printing, Laser Engraving

Product includes :

- WDS6-BLK: Wireless charger with pen holder
- WM4: Bamboo Wireless Mouse
- TM-024-BK: Black ceramic mug with bamboo
- GB-XL-BLK: Black Cardboard Packing Box





GS-026

Promotional Gift Set. Grey fabric cover with black base cardboard gift box with cushion inside for product protection and presentation.



275 x 255 x 45 mm



Screen Printing, UV Printing
Laser Engraving

Product includes :

- MB-D-BM: Dorniel Designs A5 size notebook
- PN42-BK: Black rubberized metal pen with stylus
- JU-WCMI-GY: Mousepad with wireless charger
- GB-L-RPET: Fabric with Black Cardboard Box

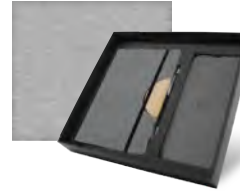

GS-027

Cork Gift Set. Cork cover with black base Cardboard gift box with cushion inside for product protection and better presentation.



275 x 255 x 45 mm



Screen Printing, UV Printing

Product includes :

- MB-05-C: Cork Cover A5 size Notebook
- JU-WCMI-CO: Cork Foldable Mousepad with Wireless Charger.
- GB-L-CO: Cork with Black Cardboard Packing Box



GS-028

Promotional Gift Set. Grey fabric cover with black base cardboard gift box with cushion inside for product protection and presentation.



275 x 255 x 45 mm



Screen Printing, UV Printing,
Laser Engraving, Laser Markings

Product includes :

- MB-D-BM: Dorniel Design A5 size notebook
- PN59-GRY: Metal Pen with RPET fabric grip
- WPB-L10K: 10,000 mAh Powerbank
- GB-L-RPET: Fabric with Black Cardboard Box

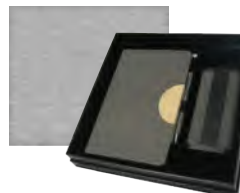



GS-029

Promotional Gift Sets. Natural Cardboard gift box with cushion inside for product protection and better presentation.

 260 x 290 x 105 mm

 Screen Printing, UV Printing
Laser Markings, Debossing

Product includes :

- TM-009-BK: Black stainless steel bottle
- MB-06-BK: Black A6 size PU notebook
- PN45-BK: Black aluminum pen with stylus
- BCH-03-L: Leather RFID protected card holder
- KH-3-BK: Black metal keychain
- GB-XL-BLK: Black Cardboard Packing Box



GS-030

Eco-Friendly Gift Sets. Natural Cardboard gift box with cushion inside for product protection and better presentation.

 260 x 290 x 105 mm

 Screen Printing, UV Printing
Laser Engraving

Product includes :

- TM-014: Glass Flask with bamboo lid
- TM-030: Glass Cup with bamboo lid
- COA-02: Cork tea coaster
- GB-XL-R: Recycled Cardboard Packing Box



GS-031

Bamboo Gift Sets. Black Cardboard gift box with cushion inside for product protection and better presentation.

 260 x 290 x 105 mm

 Screen Printing, UV Printing
DTF Printing, Laser Engraving

Product includes :

- WCP-L3: Wireless bamboo charger stand
- WM4: Bamboo Wireless Mouse
- TM-013-BK: Black double-wall SS bottle
- GB-XL-BLK: Black Cardboard Packing Box





GS-032

Promotional Gift Sets. Black Cardboard gift box with cushion inside for product protection and better presentation.

 260 x 290 x 105 mm

 Screen Printing, UV Printing
DTF Printing, Laser Engraving

Product includes :

WCP-05: Round magnetic wireless charger
MB-06-BK: A6 size black PU notebook
PN42-BK: Black metal pen with stylus
TM-071-BLK: Black double-wall SS bottle
GB-XL-BLK: Black Cardboard Packing Box



GS-033

Promotional Gift Set. Black Cardboard gift box with cushion inside for product protection and better presentation.

 420 x 297 x 100 mm

 Screen Printing, UV Printing,
Laser Markings

Product includes :

MBD-04: A5 size Dorniel Design Notebook
PN27-BK: Black pen with stylus
WM3-BLK: Wireless Mouse
CH-006-BK: PU Leather foldable ID Card Holder
TM-072-BLK: Double-wall SS Bottle with handle
GB-A3-BLK: Black Cardboard Packing Box



GS-034

Promotional Gift Set. Black Cardboard gift box with cushion inside for product protection and better presentation.

 420 x 297 x 100 mm

 Screen Printing, UV Printing

Product includes :

MBA5PU-BLK: Black A5 size PU Notebook
PN42-BK: Black metal pen with stylus
WCP-04-BLK: Desktop wireless charger stand
WM3-BLK: Wireless Mouse
KH-3-BK: Black Metal Keychain
TM-043-BLK: Double-wall SS Bottle
GB-A3-BLK: Black Cardboard Packing Box





GS-035

Bamboo Gift Set. Black Cardboard gift box with cushion inside for product protection and better presentation.

420 x 297 x 100 mm

Screen Printing, Laser Engraving

Product includes :

- MBBM-BLK-A5: A5 size Bamboo Notebook
- EFP-100: Bamboo pen with stylus
- WM4: Bamboo Wireless Mouse
- TM-074: Double-wall SS tumbler with bamboo
- WCP-L3: Wireless bamboo charger stand
- GB-A3-BLK: Black Cardboard Packing Box



GS-036

Bamboo Gift Set. Black Cardboard gift box with cushion inside for product protection and better presentation.

420 x 297 x 100 mm

Screen Printing, UV Printing, Laser Engraving

Product includes :

- MBBM-BLK-A5: A5 size Bamboo Notebooks
- EFP-100: Bamboo Pens with Stylus
- WCP-L2: Bamboo Wireless Charger
- WM4: Bamboo Wireless Mouse
- TM-011-BK: Bamboo Flask
- USB-75: Light-up logo Bamboo Flash Drive
- GB-A3-BLK: Black Cardboard Packing Box



GS-037

Bamboo Gift Set. Black Cardboard gift box with cushion inside for product protection and better presentation.

275 x 255 x 45 mm

Screen Printing, UV Printing, Laser Engraving

Product includes :

- JU-WPB-B8000: 8000 mAh Bamboo Powerbank
- CLK-13-BM: Bamboo desk and wall clock.
- PN61: Bamboo pen with bamboo ase
- KH-8-BM: Metal Keychain with bamboo
- GB-L-BLK: Black Cardboard Packing Box





GS-038

Bamboo Gift Set. Black Cardboard gift box with cushion inside for product protection and better presentation.

275 x 255 x 45 mm

Screen Printing, UV Printing
Laser Engraving

Product includes :

- MB-D-BM: Dorniel Design A5 size notebook
- USB-38: Bamboo USB flash drive 8GB
- 082-SL: Bamboo Pen
- KH-7-BM: Metal keychain with bamboo
- GB-L-BLK: Black Cardboard Packing Box



GS-039

Promotional Gift Set. Black Cardboard gift box with cushion inside for product protection and better presentation.

190 x 165 x 50 mm

Screen Printing, UV Printing
Laser Markings

Product includes :

- PB-10K-BLK: Black 10,000 mAh Powerbank with LED Screen and built-in cables.
- PR-02-BK: Black round mobile grip and stand.
- USB-68: Black metal USB flash drive - 8GB.
- GB-BK-S: Black Cardboard Packing Box



GS-040

Promotional Gift Set. Grey fabric cover with black base cardboard gift box with cushion inside for product protection and presentation.

275 x 255 x 45 mm

Screen Printing, UV Printing

Product includes :

- WDS7: Foldable wireless charging station
- JU-WCMI-GY: Foldable wireless charging mousepad.
- GB-L-RPET: Fabric with Black Cardboard Box





GS-041

Promotional Gift Set. Grey fabric cover with black base cardboard gift box with cushion inside for product protection and presentation.

 275 x 255 x 45 mm

 Screen Printing, Laser Engraving, Laser Markings

Product includes :

- MBRPET: A5 size RPET hard cover Notebook
- GB-045: Metal Pen + Keychain + Card Holder
- GB-L-RPET: Fabric with Black Cardboard Box

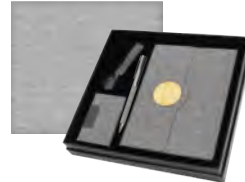

GS-042

Promotional Gift Set. Black Cardboard gift box with cushion inside for product protection and better presentation.

 275 x 255 x 45 mm

 UV Printing, Screen Printing, Laser Markings, Digital Printing with Epoxy

Product includes :

- MBD-04: A5 size Dorniel Design Notebook
- PN58-RSS: Recycled Stainless Steel Pen
- KH-01-BK: Metal Keychain with Strap
- BCH-01: Business Card Holder
- 124-S: Metal Reel Badge
- GB-L-BLK: Black Cardboard Packing Box



GS-043

Promotional Gift Set. Black Cardboard gift box with cushion inside for product protection and better presentation.

 275 x 255 x 45 mm

 Screen Printing, UV Printing, Debossing

Product includes :

- MB-06-BK: A6 size Black PU Notebook
- WM3-BLK: Wireless Mouse
- CH-006-BK: PU Leather foldable ID Card Holder
- WCP-08-BLK: 3-in-1 Foldable Wireless Charger
- PN42-BK: Stylus Metal Pen
- GB-L-BLK: Black Cardboard Packing Box

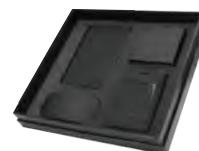



GS-044

RPET Notebook and Pen Gift Set. Black cardboard gift box with cushion inside for product protection and better presentation.

 195 x 240 x 25 mm

 **Screen Printing, UV Printing
Laser Markings, DTF Printing**

Product includes :
A5 Size RPET Fabric Notebook
Metal pen with RPET Fabric Grip



GS-045

Promotional Gift Set. Black Cardboard gift box with cushion inside for product protection and better presentation.

 185 x 26 x 172 mm

 **Laser Markings**

Product includes :
BCH-04-GRY: RPET Fabric Business Card Holder
PN59-GRY: Metal Pen with RPET fabric grip
Metal Keychain with RPET fabric



**2 pcs
22 cm tall
Wine Glass**

GS-046

Wine Glass Gift Set. Black Cardboard gift box with cushion inside for product protection and better presentation.

 290 x 265 x 130 mm

 **DTF Printing**





GS-047

Bamboo Notebook and Pen Gift Set. Natural Cardboard gift box with transparent window and cushion inside.

 205 x 255 x 25 mm

 Screen Printing, UV Printing
Debossing, Laser Engraving

Product includes :

- EFP-B2-BLK : Twist Action Bamboo Ball pen
- MBBM-BLK-A5 : A5 size Bamboo with black PU
- MB-GS : Cardboard Gift Box with Window





DORNIEL
DESIGNS



GS-048

Sadu Gift Set. Black Cardboard gift box with cushion inside for product protection and better presentation.

 275 x 255 x 45 mm

 Screen Printing, Debossing
Laser Engraving (Light-up)



A5 Size Notebook
Sadu design

10,000mah Light-up
Wireless Powerbank

DORNIEL
DESIGNS



GS-049

Sadu Gift Set. Black Cardboard gift box with cushion inside for product protection and better presentation.

 275 x 255 x 45 mm

 Screen Printing, UV Printing
Laser Engraving



500ml Glass Bottle
with Sadu sleeve

A5 Size Notebook
Sadu design

10,000mah Light-up
Wireless Powerbank



GS-050

Eco-friendly Gift Set. Black Cardboard gift box with cushion inside for product protection and better presentation.

 **355 x 355 x 105 mm**

 **Screen Printing, UV Printing
Laser Engraving, Debossing
Digital Printing with Epoxy**

Product includes :

- MB-05-C: A5 Cork cover notebooks
- 081: Cork Pens with stylus
- TM-010-BLK: Travel Tumbler with Cork Base
- 124-S: Round Metal Reel Badges
- CH-003: Rigid PVC card holders
- COA-02: Cork Tea Coasters, (two pieces)
- MPD-260-CO: Foldable Cork+PU Mousepad with Mobile and Pen Holder
- 151-BK: Ceramic Mugs with Lid and Cork Base
- GB-XXL-BLK : Black Cardboard Packaging Box



GS-051

Eco-friendly Gift Set. Black Cardboard gift box with cushion inside for product protection and better presentation.

 **355 x 355 x 105 mm**

 **Screen Printing, UV Printing,
Laser Marking & Engraving,
Digital Printing with Epoxy
Sublimation**

Product includes :

- MBRPET-GRY-BM: A5 RPET Notebooks with bamboo and magnetic closure
- PN59-GRY: RPET Metal Ball Pens, twist-action mechanism
- 144-S: Stainless Steel Bottle
- 124-S: Round Metal Reel Badges
- CH-003: Rigid PVC Card Holders
- JU-WCMI-GY: Wireless Charging Mousepad
- DSH-11: Desk Sign Holder Silver
- GB-XXL-BLK : Black Cardboard Packaging Box





GS-052

Eco-friendly Gift Set. Black Cardboard gift box with cushion inside for product protection and better presentation.



355 x 355 x 105 mm



Screen Printing, UV Printing
Laser Engraving, Debossing
DTF Printing

Product includes :

MBBM-BLK-A5 : A5 Bamboo Notebook
EFP-B2-BLK: Bamboo Pen
TM-011-BK: Bamboo Bottle
MS-08: Cube Bamboo Bluetooth Speaker
USB-38: Bamboo USB Flash Drives 16GB
WCM3-BLK: Wireless charging mousepad
GB-XXL-BLK : Black Cardboard Packaging Box



GS-053

Eco-friendly Gift Set. Black Cardboard gift box with cushion inside for product protection and better presentation.



355 x 355 x 105 mm



Screen Printing, UV Printing
Laser Engraving, Debossing

Product includes :

MBBM-BLK-A5: A5 Bamboo Notebook
EFP-B2-BLK: Bamboo Pen
TM-024-BM: Ceramic Mug with Bamboo Lid
WCP-BM7: Bamboo Wireless charger with Mug Warmer
USB-38: Bamboo USB Flash Drives 16GB
OC-BL4: Multi-charging cable
GB-XXL-BLK : Black Cardboard Packaging Box





GS-054

Promotional Gift Set. Black Cardboard gift box with cushion inside for product protection and better presentation.

 275 x 255 x 45 mm

 Screen Printing, UV Printing, Debossing Laser Markings, DTF Printing

Product includes :

- MBD-04: A5 size Black leather Notebook
- PN43: Pen with stylus
- PB-8000-BK: 8000 mAh Powerbank
- USB-64: Black Metal USB Flash Drive 8GB
- 127-BK: Black Reel Badge
- GB-L-BLK : Black Cardboard Packaging Box



GS-055

Eco-friendly Gift Set. Black Cardboard gift box with cushion inside for product protection and better presentation.

 275 x 255 x 45 mm

 UV Printing, Laser Engraving

Product includes :

- MBD-01: A5 size PU Notebook
- CH-006-BK: PU ID card holder with leather lace
- USB-76-BK: PU USB 32GB with Light-up Logo
- GB-L-BLK : Black Cardboard Packaging Box



GS-056

Eco-friendly Gift Set. Black Cardboard gift box with cushion inside for product protection and better presentation.

 275 x 255 x 45 mm

 Screen Printing, UV Printing Laser Engraving

Product includes :

- MBBM-BLK-A5: A5 size Bamboo Notebooks
- EFP-100: Bamboo Pens with Stylus
- EAR-04: Bluetooth Earbuds with Bamboo Case
- USB-38: Bamboo USB Flash Drives 16GB
- MPS-09-BM: Bamboo Phone Stands
- GB-L-BLK : Black Cardboard Packaging Box





GS-057

Eco-friendly Gift Set. Black Cardboard gift box with cushion inside for product protection and better presentation.

260 x 290 x 105 mm

Screen Printing, UV Printing, Laser Engraving

Product includes :

- SPK-BM4-WHT: Eco-Friendly Bluetooth Speaker
- WCP-BM6-WHT: Bamboo Wireless Charging Pads
- WCC-BM3-WHT: Car Phone Holder with Wireless Charger
- MPS-08: Foldable Phone Stands
- GB-XL-R : Recycled Cardboard Packaging Box



GS-058

Eco-Friendly Gift Sets. Natural Cardboard gift box with cushion inside for product protection and better presentation.

210 x 160 x 43 mm

Screen Printing, UV Printing Laser Engraving, DTF Printing

Product includes :

- JU-WCP-BR: Bamboo Charging pad
- PB-5K-BM: Powerbank 5000mAh
- EFP-100: Bamboo Pen
- GB-A5-R : Recycled Cardboard Packaging Box



GS-059

Eco-Friendly Gift Sets. Natural Cardboard gift box with cushion inside for product protection and better presentation.

210 x 160 x 43 mm

Screen Printing, UV Printing Laser Engraving, DTF Printing

Product includes :

- OC-BL3: Bamboo charging cable
- PB-5K-BM: Bamboo power bank 5000 mAh
- GB-A5-R : Recycled Cardboard Packaging Box





GS-060

Promotional Gift Set. Black Cardboard gift box with cushion inside for product protection and better presentation.

 355 x 355 x 105 mm

 Screen Printing, UV Printing
Laser Engraving, DTF Printing

Product includes :

- MB-08: A5 Size PU leather Portfolio Notebook
- CH-006-BK: PU Leather foldable ID card holder
- PN42-BK: Rubberized Barrel Metal Pen with Stylus
- TM-043-BLK: Black Travel Bottle with Smart temperature LED display
- WM3-BLK: Bluetooth Wireless Slim LED Mouse
- GB-XXL-BLK : Black Cardboard Packaging Box



GS-061

Plant a Seed Gift Sets. Pen and notebook combination. Packed in a eco-friendly pouch.

 210 x 300 mm

 Screen Printing

Product includes :

- SPS-05: Plantable Pencil - Ghaf Seed
- SPS-08: Plantable Notebook
- PCH-10: Jute Pouch



GS-COF-01

Coffee Gift Set. Contains total of 3 products as listed. Packed in a craft box for product protection and better presentation.

 115 x 150 x 100 mm

 Screen Printing, UV Printing

Product includes :

- Coffee material Travel Cup
- Coffee material Pen
- Coffee material Notepad.





GS-COF-02

Coffee Material Notebook and Pen Gift Set.
Natural Cardboard gift box with transparent window and cushion.

 205 x 255 x 25 mm

 Screen Printing, UV Printing

Product includes :

MB-GS : A5 Size coffee notebook

Coffee Pen

MB-GS : Cardboard Gift Box with Window.

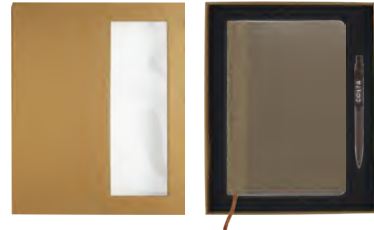

GS-AB-01

Antibacterial Gift Set. Contains total of 3 products as listed. Packed in a white box for product protection and better presentation.

 115 x 150 x 100 mm

 Screen Printing, UV Printing

Product includes :

Maxema Antibacterial Pen (optional pen)

Antibacterial White Travel Cup

Antibacterial Notepad



GS-AB-02

Antibacterial Gift Set. Contains total of 2 products as listed. Packed in a white box for product protection and better presentation.

 178 x 18 x 210 mm

 Screen Printing, UV Printing

Product includes :

Maxema Antibacterial Pen (optional pen)

Antibacterial Notepad





GS-701

Cork Material Notebook and Pen Gift Set. Cork Cardboard gift box with cushion for product protection and better presentation.

 195 x 220 x 23 mm

 Screen Printing, UV Printing

Product includes :

MB-05-C: A5 size Cork cover notebook
071-BK: Cork and wheat straw pen



GS-702

Promotional Gift Set. Optional Cork or Black PU series. Gift box with cushion inside for product protection and better presentation.

 280 x 240 x 25 mm

 Screen Printing, UV Printing
Laser Markings

Product includes :

A5 Size Notebook with Strap and metal plate
Business Card Holder
Promotional Metal Pen
Metal keychain with strap



Cork material option



Black PU material option

PRODUCT PACKAGING

Attracting customers and standing out among competitors. From the design and materials used to the messaging and branding, product packaging can make or break a product's success in the market.





GB-A5-WHT

White Packaging Box. Cardboard box with front flap opening. Made from cardboard material.

 200 x 160 x 43 mm

 Screen Printing,
UV Printing.



GB-A5-R

Recycled Packaging Box. Rectangular shaped container with a flat base and sides, made from Recycled paper material.

 200 x 160 x 43 mm

 Screen Printing,
UV Printing.



GB-A5-BLK

Black Packaging Box. Rectangular shaped container with a flat base and white interior, made from cardboard material.

 200 x 160 x 43 mm

 Screen Printing,
UV Printing.



GB-XL-CO

Recycled Packaging Box. Rectangular shaped container with a flat base and white interior, made from Recycled paper material.

 260 x 290 x 105 mm

 Screen Printing,
UV Printing.



GB-XL-R

Recycled Packaging Box. Rectangular shaped container with a flat base and sides, made from Recycled paper material.

 260 x 290 x 105 mm

 Screen Printing,
UV Printing.



GB-XL-BLK

Black Packaging Box. Rectangular shaped container with a flat base and sides, made from cardboard material.

 260 x 290 x 105 mm

 Screen Printing,
UV Printing.

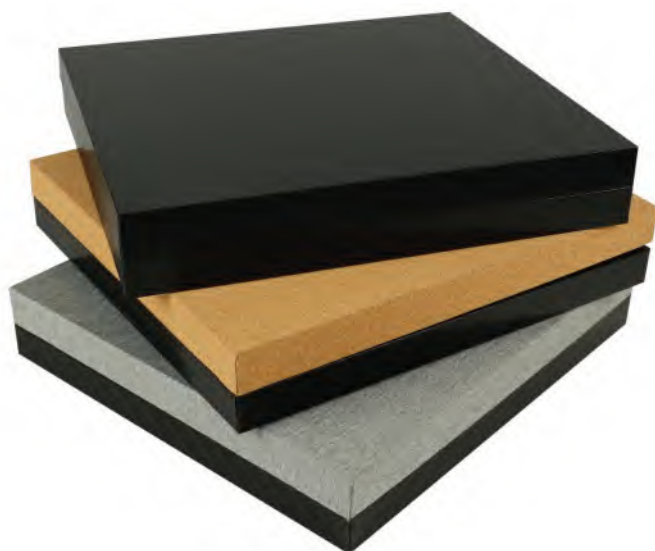

GB-L

Packaging Box. Square shaped container with a flat base and sides, made from eco-friendly materials.

 275 x 255 x 45 mm  Screen Printing, UV Printing.



GB-L-BLK
Black Cardboard Cover



GB-L-CO
Cork Material Cover



GB-L-RPET
Grey Fabric Cover



GB-XXL-BLK

Black Plain Gift Box Size XXL, which is constructed of cardboard, is an amazing advertising item that combines elegance, functionality, and versatility in a single package.

 355 x 355 x 105 mm

 Screen Printing,
UV Printing.



GB-BK-XL-P

Luxury Plain Wooden Gift Box. More than simply a container; it is a promotional tool that is adaptable, elegant, and powerful, and it has the potential to improve the image of a company.

 280 x 280 x 95 mm

 Screen Printing,
UV Printing.



GB-A3-BLK

Black Rectangular Packaging Box. Container with a flat base and sides, made from cardboard materials.

420 x 297 x 100 mm Screen Printing, UV Printing.

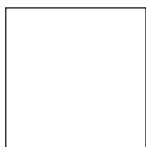

GB-161
150 x 150 mm

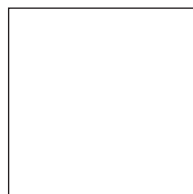

GB-162
200 x 200 mm

GS-161 / GS-162

Square shaped container with a flat base and sides, made from white cardboard material.

Available in 2 sizes Screen Printing, UV Printing.



GB-164
150 x 200 mm



GB-166
200 x 250 mm

GS-164 / GS-166

Rectangular shaped container with a flat base and sides, made from white cardboard material.

Available in 2 sizes Screen Printing, UV Printing.

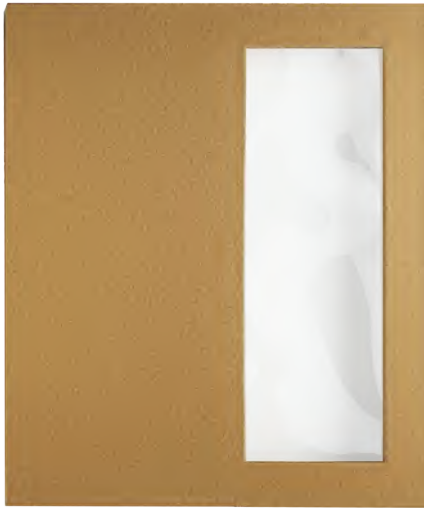

MB-GS

Notebook & Pen Gift Box. Cardboard box with clear window opening on front. Fits a normal A5 size notebook and a pen.

 **205 x 255 x 25 mm**

 **Screen Printing, UV Printing.**



HYG-25

Plastic Case, Transparent Plastic. Made of high grade durable plastic. Protective Case for Disposable Face Mask.

 **195 x 105 x 25 mm**  **Screen Printing**



267-PS

Plastic Medal Box. A stylish and economical presentation case to display a medal. Transparent Front cover with solid black base. Fits a 50mm medal.

 **75 x 105 x 15 mm**



267-PPB-XL
110 x 90 mm



267-PPB-S
55 x 40 x 22 mm



267-PPB-B
70 x 70 x 18 mm



267-MB
40 x 40 mm

Pin & Badge Packaging Box. Transparent Cover, Solid Black Plastic Base with Foam material to hold the product.

 **Available in 4 sizes**



USB-PB

PU Leather Zippered Pouch.
Available Colors: Black, Blue, Red

80 (dia.) x 40 mm Screen Printing



565-9-S

Leather Pouch for USB Flash Drive.
Available Colors: Black and Beige

70 x 40 mm Screen Printing



GB-BK-XXL

Black Leather Cover For Card Shaped USB Flash Drive.

100 x 66 mm Screen Printing



565-8

Plastic Cases For Card Shaped USB Flash Drive. This USB case's clear outside overlay provides view for your USB card.

105 x 72 mm Screen Printing



GB-PNUSB

Pen and USB Flash Gift Packing Box. Cardboard box with foam.

170 x 65 x 28 mm Screen Printing, UV Printing.



264

Rectangular Box for Pen and USB Flash Drive. This gift set has a logo space on top of the lid which allows a corporate logo to be printed by a full colour printing with epoxy.

?? mm Digital printing with epoxy



LPB-05

Bamboo Pen Case with Chromed Cap. This case has a lovely appearance and top-notch components.

160 x 25 mm

Screen Printing, UV Printing
Laser Engraving



PPB-10

Bamboo Pen Box with Velvet Interior. A lavish and fantastical gift that will delight everyone and win over your customers.

175 x 68 x 28 mm

Screen Printing, UV Printing
Laser Engraving



LPB-04

Cork Pen Box with Velvet Interior. Composed of durable cork material. A stylish and unique item.

180 x 55 x 35 mm

Screen Printing, UV Printing



GB-PNWD02

Matte Finish Veneer Wood Material Pen Box. Smooth surface, high-quality timber construction.

197 x 80 x 45 mm

Screen Printing, UV Printing
Laser Engraving



LPB-01

Leather Pen Packaging Box. It can be a good choice to pack your gift with your branding and customize your gift.

175 x 68 x 38 mm

Screen Printing



LPB-02

Leather Gift Pen Packaging Box. More premium than other types of packaging.



195 x 95 x 45 mm

Screen Printing



GB-PNWD01

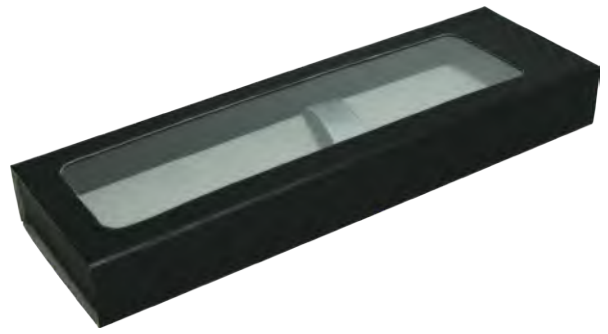

Glossy black design high quality hard wood material With soft velvet interior.

 200 x 80 x 45 mm  Screen Printing



PPB-02

Black Cardboard material box with velvet inside. Dependable and durable, resistant to wear and tear, and long-lasting.

 185 x 60 x 25 mm  Screen Printing



PPB-03

Cardboard Pen Packaging Box. Great packing design, cardboard with felt material.

 180 x 65 x 25 mm  Screen Printing



PPB-05

Matte black pen packing box cardboard material.

 175 x 45 x 25 mm  Screen Printing



95



Velvet Pen Pouches. It contains a tiny pocket-like slot where you can tuck your pen.

 159 x 35 mm  Heat Transfer



279

Plastic Pen Packing Box. Transparent Plastic Box to fully show your Pen.

 195 x 95 x 45 mm  Screen Printing

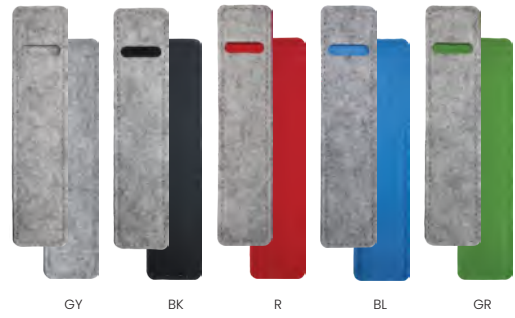

GY BK R BL GR

PNC

Felt material pen packaging pouch. The case is made of felt in Vivid colors.

 45 x 165 mm

 Screen Printing

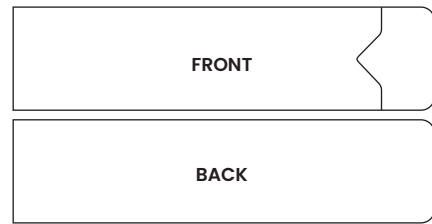

Customized Pen Case

Print your own Design with Logo. The Pen case is made of FSC, 300g paper.

 44 x 168 mm

 Offset Printing

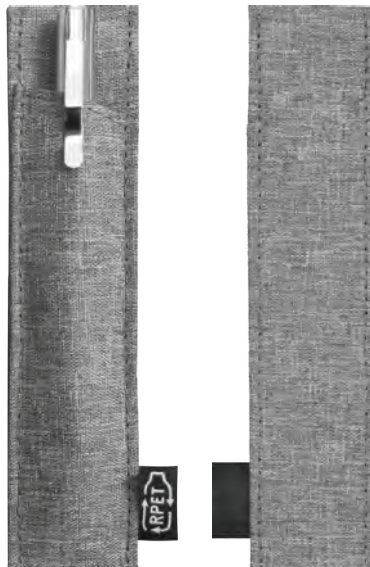

PNC-100-GRY

RPET fabric pen pouches with textured design. Simple and portable size with textured design.

 35 x 158 x 4.5 mm

 Screen Printing

CUSTOMIZED PRODUCTS

One highly effective strategy that has been gaining popularity is offering customized products. Whether it's personalized apparel, unique accessories, or bespoke gifts, customization allows customers to create products that reflect their individual style and preferences.

Turn your Ideas to a Product!



Submit your Design



Product Estimate



Confirmation and Payment



Production Starts



Fast Delivery

Customized Silicone USB Flash Drive

One of the best ways to increase brand recognition is to stand out with a custom silicone USB drive. Virtually any shape imaginable can be recreated on these material which has a high quality flash drives. Tested chip inside the product. Available capacity : 4, 8, 16 or 32 GB.

Minimum Order Quantity

500 pcs.



Customized Silicone Wristbands

Silicone Wristband is one of the most popular gift item with its affordable price and unique advertisement. We can promote your logo or message by Embossing / Debossing or Debossing with color filling.

Minimum Order Quantity

500 pcs.



Customized Silicone Keychains

Turn your standard wristbands into wristband keychains! With the addition of special hardware, we're able to turn almost any wristband into a keychain.

Minimum Order Quantity

500 pcs.



Customized Bamboo Keychains

Create your own shape of bamboo keychains. Just send us your design, preferred size and we will make it for you. Your logo or message can be printed with laser engraving.

Minimum Order Quantity

500 pcs.



Customized PVC Key Rings & Magnet

Our durable PVC material can withstand the messiest adventures without a problem. Create flexible and vibrant designs with unlimited color options. You can create any shape and size that echoes your brand voice.

Minimum Order Quantity

250 pcs.



Customized PVC Plastic Cards

PVC plastic cards are part of our daily life. Most people are carrying a least one card, whether it's their company ID card, their health club card or a simple photo card. We offer these cards on full color edge-to-edge printing.

Minimum Order Quantity

500 pcs.



Customized Pins & Badges

Create a badge using your own design. Just send us your design, preferred size and we will make it for you. It can be chrome, nickel, brass or gold finishing with soft enamel color filing.

Minimum Order Quantity

500 pcs.



Customized Coins

Whether it's sports, academics, business, recognition or for a special event, Promotional coins are a unique reward to celebrate any achievement. Personalize and brand your piece with taglines or logos.

Minimum Order Quantity

100 pcs.



Custom-made Metal Tags

for Laser Engraving or Full Color UV Printing

Minimum Order Quantity

100 pcs.



Customized Embroidery Patch

We're your one-stop source if you need custom patches for sports teams, businesses, military units, motorcycle clubs and events, camping, Scouting, martial arts or any other purpose. Our custom patches are perfect for uniforms, Bags, Jackets or any other use.

Minimum Order Quantity

100 pcs.



Customized Ribbon Wristbands

Event Wristbands in soft polyester, full color sublimation printing on one side. Available in 10 mm or 15 mm width, Also available in 2 different clamp / clip options. Adjustable plastic clamp or metal clamp.

Minimum Order Quantity

250 pcs.



Custom-made Coated Aluminum Name Badge For Full Color Sublimation

Minimum Order Quantity

50 pcs.

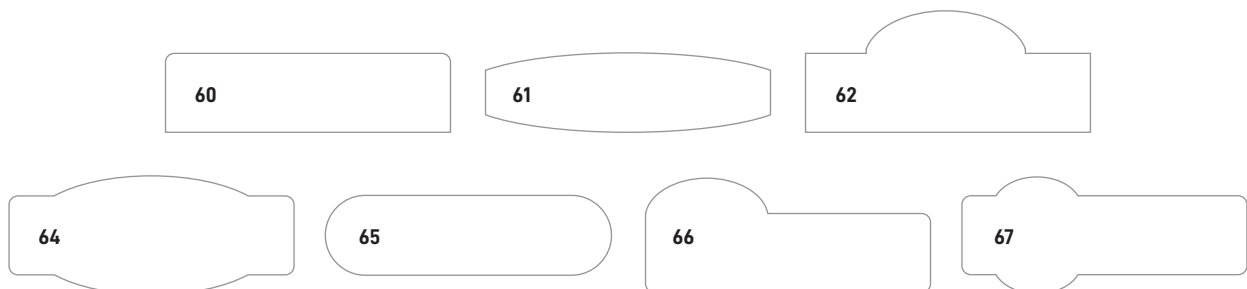

Available in 3 different colors :



Customized Magnets

Feature a magnetic back behind high quality color printing of your logo or illustration. Great for different purpose and usage such as the above list;

Minimum Order Quantity

500 pcs.



Fridge Magnet | Calendar Magnet | Business Card Magnet | Clip Magnet | Bookmark Magnet | Car Magnets

Customized Scarf

Design your custom scarves to promote your team, event, business or even on personal use. Available in Polyester, Satin or Mesh material.

Minimum Order Quantity

250 pcs.



Customized Paper Shopping Bag

Create a stylish packaging solution for your business, Custom paper bags are a perfect addition to your marketing plan and are an absolute must for any retailers. Personalizing paper bags with your logo can greatly boost your brand exposure.

Minimum Order Quantity

500 pcs.



Customized Acrylic Awards

Create an award using the shape of your logo or design. We can cut it according to your design and print in full color.

Minimum Order Quantity

250 pcs.



Customized Acrylic Puzzle with UV Printing

Made with Acrylic Material, Plastic material with outstanding strength, stiffness, and clarity. Combined with a full colour UV printing it would be a great gift or presentation to your clients. Can be customized by your own preferred size.

Minimum Order Quantity

100 pcs.

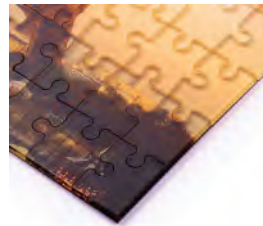

Custom Made Cutted Acrylics

Acrylic Signage, Tokens, Accessories

Minimum Order Quantity

100 pcs.



Customized Table Calendars

One of the essentials that we refer to every day is a calendar. So when we spend so much time referring to it, for all our important events and plans. Personalized calendars with your logo makes for a great gift to customers to remember you.

Minimum Order Quantity
250 pcs.



Customized QR Code Menu

Available in different designs, made from hardwood material in different variations such as; Walnut dark, walnut brown, walnut light. Printing in full colour sublimation, screen printing, and laser engraving.

Minimum Order Quantity
250 pcs.



Customized Tissue Box

Get Custom Tissue Boxes personalized with your custom logo & design! Makes a great promotional product available on different sizes. 100 ply tissue included.

Minimum Order Quantity
500 pcs.



Custom-made Instagram Frame

Great for events / parties and marketing Instagram pages for extra exposure.
Fully Customize your details / size & even colors.

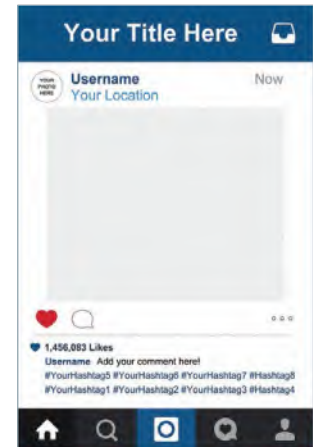

Customized Canvas Printing

Print your designs on our canvas for your home or office, Our canvas comes in custom sizes which you can choose and canvas photo prints can be a really good gift for someone with a new office or a housewarming gift, as it only brightens up the wall.



Customized Canvas Printing with Frame



Customized Roll ups

We offer custom printed classic roll up banners. Our banners are perfect lightweight portable advertising tool. Ideal for conferences, promotional events, trade expos and in-store displays, a high-quality pull-up or roll-up banner is a guaranteed route to increasing your brand's visibility.



Custom-made Boxes

Create custom packaging for your Brand with your own desired size, materials & print. Optional materials such as ; Wide Selection of Leather, Velvet, Hardboard & more.



Optional Printing on the Boxes

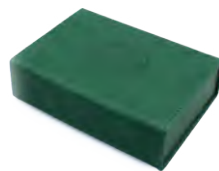

Debossing



Full Colour UV Printing



Screen Printing

Custom-made Box can also have a customized full color offset label & cover



Custom-made Leather Products

Create a leather product using your preferred material & color, then brand it with debossing or full color printing.



Certificate Holder



Menu Cover with Screw



Office Desk Organizer



Leather Tea Coaster



Pen / Pencil Holder



Restaurant Bill Folder

Below are the available material & colors



Customized Notebooks

Full Color Edge-to-edge Covers on your A5 Size Notebooks.
Have your Logo with background or any advertising printed by full color printing & make it as a cover on your A5 Notebooks.



Backside



Frontside



Backside



Frontside



Customized Sticky Notes

Our personalized Sticky Notes are great for your office use, and can help you keep track of just about anything. Whether you're writing a to-do list or reminding yourself of an important meeting, we have a wide range of custom sticky notepads to choose from. Use as gifts, giveaways, advertising tools and more.



Half Page
Stick Notes
with logo
& details

1/4 Page
Stick Notes
with logo
& details



1/8 Page
Stick Notes
with logo

Assorted Colours
Stick Notes
Strips

Fully Customize
according to your
preferred size & style.

Customized Brochures

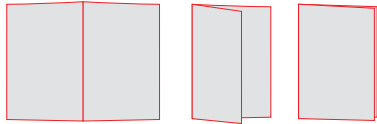

HALF FOLD

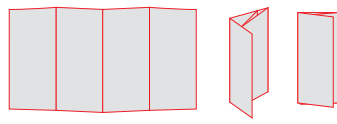

ROLL FOLD

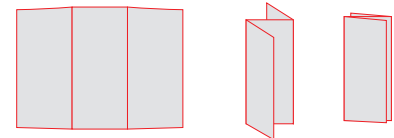

Z FOLD

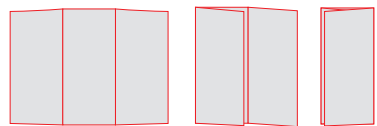

TRI FOLD

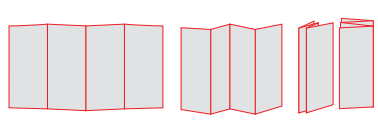

QUAD FOLD

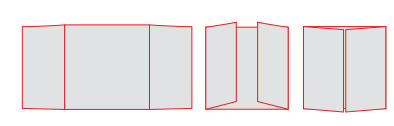

GATE FOLD

B4 – Brochure

Size : 34 x 24 cm

4 Colour, 1 Sides & 2 Sides printing. Material : Wood Free Paper 100 gsm, 170 gsm, Glossy Paper 350 gsm – Matte & glossy laminated.

Product Size : Before cutting – 34 x 24 cm, After cutting – will be cut off 3mm from each side. In this product you need to specify the folding type and folding lines.

Turnaround : 5-6 Business Days

A4 – Brochure

Size : 29 x 20 cm

4 Colour, 1 Sides & 2 Sides printing. Material : Wood Free Paper 100 gsm, 170 gsm, Glossy Paper 350 gsm – Matte & glossy laminated.

Product Size : Before cutting – 29 x 20 cm, After cutting – will be cut off 3mm from each side. In this product you need to specify the folding type and folding lines.

Turnaround : 5-6 Business Days

DL (2UPs) – Brochure

Size : 20 x 19.4 cm

4 Colour, 1 Sides & 2 Sides printing. Material : Wood Free Paper 100 gsm, 170 gsm, Glossy Paper 350 gsm – Matte & glossy laminated.

Product Size : Before cutting – 20 x 19.4 cm, After cutting – will be cut off 3mm from each side. In this product you need to specify the folding type and folding lines.

Turnaround : 5-6 Business Days

DL (4UPs) – Brochure

Size : 38.7 x 20 cm

4 Colour, 1 Sides & 2 Sides printing. Material : Wood Free Paper 100 gsm, 170 gsm, Glossy Paper 350 gsm – Matte & glossy laminated.

Product Size : Before cutting – 38.8 x 20 cm, After cutting – will be cut off 3mm from each side. In this product you need to specify the folding type and folding lines.

Turnaround : 5-6 Business Days

Customized Posters



B2 – Posters

Size : 48.5 x 69 cm

4 Colour, 1 Sides & 2 Sides printing.
Material : Glossy Paper 200 gsm.

Poster Size : Before cutting – 48.5 x 69 cm, After cutting – will be cut off 5mm from each side. In this product you need to specify the folding type and folding lines.

Turnaround : 3 Business Days



B3 – Poster

Size : 34 x 48 cm

4 Colour, 1 Sides & 2 Sides printing.
Material : Glossy Paper 200 gsm

Poster Size : Before cutting – 34 x 48 cm, After cutting – will be cut off 3mm from each side. In this product you need to specify the folding type and folding lines.

Turnaround : 3 Business Days



A2 – Posters

Size : 43.5 x 59 cm

4 Colour, 1 Sides & 2 Sides printing.
Material : Glossy Paper 200 gsm.

Poster Size : Before cutting – 48.5 x 69 cm, After cutting – will be cut off 5mm from each side. In this product you need to specify the folding type and folding lines.

Turnaround : 3 Business Days



A3 – Poster

Size : 29.7 x 42 cm

4 Colour, 1 Sides & 2 Sides printing.
Material : Glossy Paper 200 gsm

Poster Size : Before cutting – 34 x 48 cm, After cutting – will be cut off 3mm from each side. In this product you need to specify the folding type and folding lines.

Turnaround : 3 Business Days

Customized Flyers



A5 Size - Flyer

Size : 21 x 14.8 cm

4 Colour, 1 Sides & 2 Sides printing.
Flyer - Glossy material 170 gsm

Turnaround : 4 Business Days



A3 Size - Flyer & Brochure

Size : 29.7 x 42 cm

4 Colour, 1 Sides & 2 Sides printing.
Flyer - Glossy material 135 gsm & 170 gsm
Brochure - Glossy material 170 gsm with folding

Turnaround : 4 Business Days



A4 Size - Flyer & Brochure

Size : 29.7 x 21 cm

4 Colour, 1 Sides & 2 Sides printing.
Flyer - Glossy material 170 gsm
Brochure - Glossy material 170 gsm with folding

Turnaround : 4 Business Days



Table Mat

Size : 29.7 x 42 cm

4 Colour, 1 Sides & 2 Sides printing.
Material : Wood Free Paper 100 gsm & 135 gsm.

Turnaround : 4 Business Days

Premium Business Card



Spot UV Matte Laminated 350 gsm

Code : SB-104/1

Quantity : 1000 pcs

4 Colour, 2 Sides, Spot UV, Matte Laminated 350 gsm.
Before Cutting Size : 9.2 x 5.7 cm, After Cutting : 9 x 5.5 cm
You can print in larger sizes up to 34.2 x 46 cm

Turnaround : 2 - 3 Business Days

Rounded Corner Spot UV Matte Laminated 350 gsm

Code : SB-203/1

Quantity : 1000 pcs

4 Colour, 2 Sides, Spot UV, Matte Laminated 350 gsm, Rounded Corner
Before Cutting Size : 9.5 x 6 cm, After Cutting : 9 x 5.5 cm
The areas you select will be with Spot UV.

Turnaround : 2 - 3 Business Days

Linen Paper 350 gsm

Code : PB-202

Quantity : 1000 pcs

4 Colour, 2 Sides, Linen Paper 350 gsm
Before Cutting Size : 9.2 x 5.7 cm, After Cutting : 9 x 5.5 cm
You can print in larger sizes up to 34.2 x 46 cm

Turnaround : 2 - 3 Business Days

Gold Foil Linen Paper 350 gsm

Code : PB-201

Quantity : 1000 pcs

4 Colour, 2 Sides, Linen Paper 350 gsm.
Before Cutting Size : 9.2 x 5.7 cm, After Cutting : 9 x 5.5 cm
The areas you select will be with Foil Stamped.

Turnaround : 2 - 3 Business Days

Rounded Corner PET Matte Laminated 760 mic

Code : PB-205

Quantity : 1000 pcs

4 Colour, 2 Sides, PET Matte Laminated 350 gsm. Rounded Corner
Before Cutting Size : 9.5 x 6 cm, After Cutting : 9 x 5.5 cm

Turnaround : 2 - 3 Business Days

Premium Business Card



Rounded Corner PET Glossy Laminated 760 mic

Code : PB-204

Quantity : 1000 pcs

4 Colour, 2 Sides, PET Glossy Laminated 760 mic. Rounded Corner
Before Cutting Size : 9.5 x 6 cm, After Cutting : 9 x 5.5 cm

Turnaround : 7 Business Days



Rounded Corner Gold Foil PET Glossy Laminated 760 mic

Code : PB-206

Quantity : 1000 pcs

4 Colour, 2 Sides, PET Glossy Laminated 760 mic, Rounded Corner.
Before Cutting Size : 9.2 x 5.7 cm, After Cutting : 9 x 5.5 cm
The areas you select will be with Foil Stamped.

Turnaround : 7 Business Days



Velvet Laminated 350 gsm

Code : SB-102

Quantity : 1000 pcs

4 Colour, 2 Sides, Velvet Laminated 350 gsm,
Before Cutting Size : 9.5 x 6 cm, After Cutting : 9 x 5.5 cm
You can print in larger sizes up to 34.2 x 46 cm

Turnaround : 7 Business Days



Rounded Corner Spot UV Velvet Laminated 760 mic

Code : PB-207

Quantity : 1000 pcs

4 Colour, 2 Sides, Spot UV, Velvet Laminated 760 mic.
Before Cutting Size : 9.2 x 5.7 cm, After Cutting : 9 x 5.5 cm
The areas you select will be with Spot UV.

Turnaround : 7 Business Days



Round Corner Gold Foil Spot UV Velvet Laminated 760 mic

Code : PB-208

Quantity : 1000 pcs

4 Colour, 2 Sides, Gold Foil, Spot UV Velvet Laminated 760 mic. Rounded Corner
Before Cutting Size : 9.5 x 6 cm, After Cutting : 9 x 5.5 cm
The areas you select will be with Spot UV & Foil Stamped.

Turnaround : 7 Business Days

Standard Business Card



Glossy 350 gsm (No Cover)

Code : SB-101

Quantity : 1000 pcs

4 Colour, 2 Sides, Glossy (no cover) 350 gsm.
Before Cutting Size : 9.2 x 5.7 cm, After Cutting : 9 x 5.5 cm
You can print in larger sizes up to 34.2 x 46 cm

Turnaround : 2 - 3 Business Days



Glossy Laminated 350 gsm

Code : SB-103

Quantity : 1000 pcs

4 Colour, 2 Sides, Glossy Laminated 350 gsm.
Before Cutting Size : 9.2 x 5.7 cm, After Cutting : 9 x 5.5 cm
You can print in larger sizes up to 34.2 x 46 cm

Turnaround : 2 - 3 Business Days



Rounded Corner Glossy Laminated 350 gsm

Code : PB-202

Quantity : 1000 pcs

4 Colour, 2 Sides, Glossy Laminated 350 gsm, Rounded Corner.
Before Cutting Size : 9.5 x 6 cm, After Cutting : 9 x 5.5 cm

Turnaround : 2 - 3 Business Days



Matte Laminated 350 gsm

Code : SB-104

Quantity : 1000 pcs

4 Colour, 2 Sides, Matte Laminated 350 gsm.
Before Cutting Size : 9.2 x 5.7 cm, After Cutting : 9 x 5.5 cm
You can print in larger sizes up to 34.2 x 46 cm

Turnaround : 2 - 3 Business Days



Rounded Corner Matte Laminated 350 gsm

Code : PB-203

Quantity : 1000 pcs

4 Colour, 2 Sides, Matte Laminated 350 gsm. Rounded Corner
Before Cutting Size : 9.5 x 6 cm, After Cutting : 9 x 5.5 cm

Turnaround : 2 - 3 Business Days

Stationeries & Letterheads



